

**A STUDY OF DISCREPANCY RESULTS IN PARTIALLY
ORDERED SETS**

A Thesis
Presented to
The Academic Faculty

by

David M. Howard

In Partial Fulfillment
of the Requirements for the Degree
Doctor of Philosophy in the
School of Mathematics

Georgia Institute of Technology
August 2010

A STUDY OF DISCREPANCY RESULTS IN PARTIALLY ORDERED SETS

Approved by:

Professor William T. Trotter, Advisor
School of Mathematics
Georgia Institute of Technology

Professor Dana Randall
School of Computer Science
Georgia Institute of Technology

Professor Luca Dieci
School of Mathematics
Georgia Institute of Technology

Professor Prasad Tetali
School of Mathematics and School of
Computer Science
Georgia Institute of Technology

Professor Richard Duke
School of Mathematics
Georgia Institute of Technology

Date Approved: 18 May 2010

*In loving memory of my Grandma Mary, I wish you could have seen
me graduate. I will miss you.*

ACKNOWLEDGEMENTS

There are so many influences in my life that have helped me get to where I am today. First, I want to thank my family and my beautiful wife for their love and support. To my advisor and friend, I can never repay the insight and guidance both professionally and personally that you have given me, know that I am forever indebted to you. I would like to thank the research group (Mitch Keller, Stephen Young, Csaba Biro, and Noah Streib) for putting up with my antics and for the numerous times they have helped me throughout the years. To the defense committee for accepting this thesis. Thank you to all the great teachers I have had throughout my academic life, that have helped me to reach the highest level of academic achievement. Finally, to the 2004 Red Sox for winning the World Series and breaking The Curse.

TABLE OF CONTENTS

DEDICATION		iii
ACKNOWLEDGEMENTS		iv
LIST OF TABLES		vii
LIST OF FIGURES		viii
SUMMARY		x
I INTRODUCTION		1
1.1	Background	1
1.2	Definitions and Notation	2
1.3	Interval Orders and Semiorders	5
1.4	The Different forms of Discrepancy in Posets	6
II 3-DISCREPANCY-IRREDUCIBLE POSETS OF WIDTH 2		9
2.1	The infinite family \mathcal{J}_3^2	11
2.2	Proof of Theorem 11	12
2.3	Conclusion	24
III t-DISCREPANCY		27
3.1	Introduction	27
3.2	Elementary Results	28
3.3	Comparability Invariance	29
3.4	Special Classes of Posets	31
3.5	Computing $d_t(P)$ is NP-Complete	38
3.6	Semiorders	40
3.7	Conclusion and Future Work	52
IV TOTAL LINEAR DISCREPANCY		53
4.1	Introduction	53
4.2	Total Linear Discrepancy	54

4.3	Special Classes of Posets	57
4.4	Conclusion and Future Work	58
V	WHEN WEAK DISCREPANCY EQUALS LINEAR DISCREP-	
	ANCY	59
5.1	Introduction	59
5.2	Preliminaries	60
5.3	Weak Discrepancy Preliminaries	62
5.4	(d, d) -irreducible Posets	62
5.5	Characterization of \mathcal{W}_d	66
5.6	Conclusion and Future Work	67
VI	CONCLUSION	69
	REFERENCES	71

LIST OF TABLES

- 1 The ranges $R(x_i)$ when $k = 2$, $t = 2$, $n = 7$, and the algorithm applied to the semiorder P shown in Figure 28. 48

LIST OF FIGURES

1	S ₃	3
2	A 4 + 5	4
3	An interval order with interval representation	5
4	Three members of the infinite family \mathcal{J}_3^2	12
5	Members of the infinite family \mathcal{J}_3^2 derived from (a) \mathbf{M}_8 and (b) \mathbf{M}_{10} .	13
6	Forbidden minimal element structure	14
7	2 + 2 start with one chain being height 2 (not a 2 + 3)	15
8	A 3-discrepancy-irreducible poset cannot begin as above.	15
9	A forbidden beginning	16
10	If the 3-discrepancy-irreducible poset is not 1 + 5 or 2 + 3 , the smallest elements of the two chains must be in this configuration.	16
11	Since there is no unique maximum, we have this configuration.	17
12	This shows there must be more than 3 elements in the left chain.	17
13	Supposing the 4th element in the left chain were comparable to the minimal element in right chain	18
14	(a) A possible labeling leaving bottom element out. (b) A relabeling of (a)	18
15	Induction structure and labeling	20
16	The base case	20
17	If t is above elements with label $2k + 3$	21
18	This forbidden poset shows v' is incomparable to v_{2k+1}	21
19	The two options if v' were to be the last element in a chain	22
20	Supposing v'' were comparable to v_{2k+1}	23
21	The four 3-discrepancy-irreducible posets on 10 points with the forced labeling excluding t	25
22	2 examples of 4-discrepancy-irreducible posets	25
23	List of Exceptional 3-discrepancy-irreducible posets of width 3	26

24	Two posets with the same comparability graph but with different t -discrepancy.	30
25	The posets S_3 and S_4 together with 2-optimal labelings of them. . . .	31
26	Optimal labeling functions for posets P_1, P_2, P_3 when $t = 3$. In each, the height of a point is the value of its label.	33
27	A poset P and its 3-duplicated poset P'	39
28	A semiorder P and a representation of it as a unit interval order. . . .	43
29	Poset F labeled with net heights.	55
30	A element of \mathcal{W}_3 on 13 points.	68
31	Two posets that have dimension larger than the linear discrepancy	70

SUMMARY

In 2001, Fishburn, Tanenbaum, and Trenk published a pair of papers that introduced the notions of linear and weak discrepancy of a partially ordered set or poset. Linear discrepancy for a poset is the least k such that for any ordering of the points in the poset there is a pair of incomparable points at least distance k away in the ordering. Weak discrepancy is similar to linear discrepancy except that the distance is observed over weak labelings (i.e. two points can have the same label if they are incomparable, but order is still preserved). My thesis gives a variety of results pertaining to these properties and other forms of discrepancy in posets. The first chapter of my thesis partially answers a question of Fishburn, Tanenbaum, and Trenk that was to characterize those posets with linear discrepancy two. It makes the characterization for those posets with width two and references the paper where the full characterization is given. The second chapter introduces the notion of t -discrepancy which is similar to weak discrepancy except only the weak labelings with at most t copies of any label are considered. This chapter shows that determining a poset's t -discrepancy is NP-Complete. It also gives the t -discrepancy for the disjoint sum of chains and provides a polynomial time algorithm for determining t -discrepancy of semiorders. The third chapter presents another notion of discrepancy namely total discrepancy which minimizes the average distance between incomparable elements. This chapter proves that finding this value can be done in polynomial time unlike linear discrepancy and t -discrepancy. The final chapter answers another question of Fishburn, Tanenbaum, and Trenk that asked to characterize those posets that have equal linear and weak discrepancies. Though determining the answer of whether the weak discrepancy and linear discrepancy of a poset are equal is an NP-Complete

problem, the set of minimal posets that have this property are given. At the end of the thesis I discuss two other open problems not mentioned in the previous chapters that relate to linear discrepancy. The first asks if there is a link between a poset's dimension and its linear discrepancy. The second refers to approximating linear discrepancy and possible ways to do it.

CHAPTER I

INTRODUCTION

1.1 Background

Partially ordered sets arise very frequently in everyday life. Often it becomes natural and necessary to compute a ranking of these posets that respects the partial order's comparabilities. This ranking in some cases may allow ties and other times may not. Additionally, this ranking introduces details that are not present in the poset, as such certain incorrect observations may be made about the original poset. Specifically, two elements that are not comparable may appear far apart in the ranking and this may create an unfair bias between these two elements.

As an example, two baseball analysts want to publish a list of the top 25 baseball players for the year. They each make their list separately and then take the intersection of the lists to create a partially ordered set. Thus, a player would be ranked higher if and only if he was ranked higher under both analyst's rankings. The goal in compiling a final ranking would be to have players that were ranked in opposite order be placed near each other so as not to favor either analyst's particular ranking.

As a second example, at a medical triage many patients may be admitted with a variety of different symptoms and as a result it may be unclear who are the most important patients for the doctors to see first. Is it more important to see a patient who has stomach pains versus a patient whose head hurts? Clearly, in this model a patient who has been shot or is having a heart attack should be seen immediately and before someone who has back pain. This model can be viewed as a partial ordered set and again it would seem fair if the wait time between patients that are incomparable (intake cannot determine which patient is more important to see first) is minimized.

As one final example, suppose a manager wants to assign fair pay grades for employees at his company. Some employees are clearly more essential to the company and their work may be more specialized than others and as such should be paid more than other staff. Having said this it may be impossible to determine whether a person in HR is more important than an engineer working on a specific project. Again this model is a partially ordered set and it would seem fair to put incomparable employees in equivalent pay grades or as close as possible. This differs from the first two examples as in this example incomparable employees can be assigned the same pay grade.

These three examples (drawn largely from [23]) all refer to finding “fair” rankings in partially ordered sets. The goal of the first two examples is to find a ranking that witnesses the linear discrepancy of the partial order. In the third example the ranking refers to finding an ordering that witnesses the weak discrepancy of the partially ordered set. An exact definition of these terms will be defined in the next section.

1.2 *Definitions and Notation*

A *partially ordered set* (or *poset*) $\mathbf{P} = (X, P)$ is a set X with a binary relation P that is reflexive, antisymmetric, and transitive on the set X . We call X the *ground set* of the poset \mathbf{P} and refer to P as the partial order. When it is clear that there is only one poset being discussed, often the reference to the partial order is dropped and instead of writing $x \in X$ as an element of the ground set, we will use $x \in \mathbf{P}$. When $(x, y) \in P$, we write $x \leq y$ or $y \geq x$ interchangeably. In the case $(x, y) \in P$ and $x \neq y$ we may write $x < y$ or $y > x$, again interchangeably. We say two elements are *comparable* in \mathbf{P} if either $x \leq y$ or $y \leq x$. If two elements are not comparable, then they are *incomparable* and we use the notation $x || y$. In the case that $x < y$ and there is no element $z \in X$ such that $x < z < y$, we say y *covers* or is a *cover* of x and use the notation $x \prec y$ or $y \succ x$. We say x is a *minimal element* or simply *minimal* if

x does not cover any element in \mathbf{P} . Similarly, we define an element x to be a *maximal element* or *maximal* if no elements covers it.

It is often the case that visualizing a poset will be necessary to facilitate the ideas of a proof. In such cases we refer to a *Hasse Diagram* of a poset where elements of the poset are drawn in the Cartesian plane with the following restrictions:

- 1 If $x < y$ in the poset then the vertical coordinate of x must be less than the vertical coordinate of y
- 2 If $x < y$ then there is a line connecting x and y in the plane.

Given a Hasse Diagram of a poset $\mathbf{P} = (X, P)$, it is simple to determine if $(x, y) \in P$ by seeing if there is a downward path from y to x in the diagram.

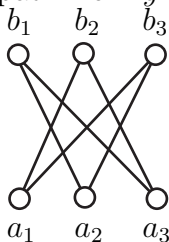

Figure 1: \mathbf{S}_3

The diagram shown in Figure 1 is a picture of poset called \mathbf{S}_3 . From this Hasse diagram one can see that each maximal element has a unique minimal element with which it is incomparable and it is comparable to all other minimal elements. This poset is a member of the class of *standard example* posets. In general, \mathbf{S}_n is the standard example with n maximal elements and n minimal elements such that each maximal element has a unique minimal element with which it is incomparable.

Let $\mathbf{P} = (X, <_P)$ and $\mathbf{Q} = (Y, <_Q)$ be two posets. If $Y \subseteq X$ and for every $a, b \in Y$ $a <_P b \iff a <_Q b$ then \mathbf{Q} is a subposet of \mathbf{P} . The *dual* of $\mathbf{P} = (X, <_P)$ denoted \mathbf{P}^d has the same ground set X and $x <_P y$ is equivalent to $y <_{P^d} x$. Notice that each member of the class of standard examples is isomorphic to its own dual, such posets are called *self-dual*. Another such example of posets that are self-dual are

sums of disjoint chains. Figure 2 shows such an example. We denote these posets by boldfaced numbers (the number of points in each chain) separated by plus signs.

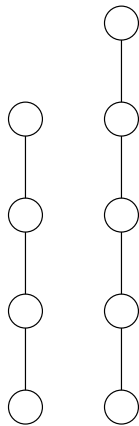

Figure 2: A **4 + 5**

A *chain* or *total order* is a set of points that are pairwise comparable. The cardinality of the largest chain in a poset is defined as the *height* of the poset. Similarly, an *antichain* is a set of elements such that every pair of distinct points x, y from the set is incomparable ($x \parallel y$). The size of the largest antichain in a poset is defined as the *width* of the poset.

If S is a subset of the groundset of a poset \mathbf{P} , we define the downset, $D(S)$, and the upset of S , $U(S)$, as follows:

$$D(S) = \{x : x < s \text{ for some } s \in S\}$$

$$U(S) = \{x : x > s \text{ for some } s \in S\}$$

Also, we denote the downset of an element y as $D(y)$ in place of $D(\{y\})$.

A *critical pair* in a poset \mathbf{P} is a pair of incomparable elements $x, y \in \mathbf{P}$ such that $D(x) \subseteq D(y)$ and $U(y) \subseteq U(x)$.

A *linear extension* L of a partial order \mathbf{P} is a total order such that all relations in the partial order are preserved. Using Figure 1 a sample linear extension of this poset would be:

$$a_1 \leq a_2 \leq a_3 \leq b_4 \leq a_4 \leq b_3 \leq b_2 \leq b_1$$

The set of all possible linear extensions of a poset \mathbf{P} is denoted $\varepsilon(\mathbf{P})$. The *height of an element x in L* is denoted $h_L(x)$. Thus, for the above linear extension the height of a_4 is 5.

A *realizer* of a poset \mathbf{P} is a set of linear extensions of \mathbf{P} such that their intersection is \mathbf{P} . Thus, for all $x, y \in \mathbf{P}$, if $x||y$ then there exists at least one linear extension with x over y and one with y over x . The dimension of \mathbf{P} is the fewest number of linear extensions needed in a realizer.

1.3 Interval Orders and Semiorders

Interval orders are a special class of posets that have a geometric representation. If you take a set of intervals on the real line one can define an order relation between intervals by saying one interval is less than another if it lies entirely to the left of the other. The set of interval orders are those posets that have such an interval drawing and such a drawing is called an *interval representation*. Thus, for example Figure 3 shows a set of labelled intervals and the corresponding poset.

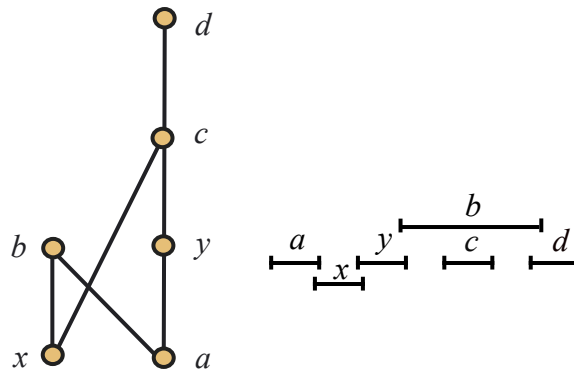

Figure 3: An interval order with interval representation

The following was originally proven by Fishburn [5] that gives a way to easily determine if a poset is an interval order or not.

Lemma 1. *Let \mathbf{P} be a poset. The following four statements are equivalent*

- 1 \mathbf{P} is an interval order.

2 \mathbf{P} does not have a $\mathbf{2} + \mathbf{2}$ as a subposet.

3 For every $x, y \in \mathbf{P}$ either $D(x) \subseteq D(y)$ or $D(y) \subseteq D(x)$

4 For every $x, y \in \mathbf{P}$ either $U(x) \subseteq U(y)$ or $U(y) \subseteq U(x)$

A subclass of interval orders is the class of semiorders. Posets that have an interval representation in which every interval has equal length are exactly the members of this class.

The following theorem was originally proven in a different form by Scott and Suppes.[21]

Theorem 2. *Let \mathbf{P} be an interval order. \mathbf{P} is a semiorder if and only if it does not contain a $\mathbf{3} + \mathbf{1}$ as a subposet.*

1.4 The Different forms of Discrepancy in Posets

Discrepancy is the central theme of this dissertation, and there are a variety of different forms each with the central idea of looking to minimize the distance between incomparable elements. With that in mind, the first form of discrepancy, weak discrepancy was the first measure developed, and the idea is to minimize the maximum distance between incomparable elements over all possible weak labellings.

Definition 3. (Weak Discrepancy) Let $\mathbf{P} = (V, \prec)$ be a poset. An integer-valued function $f : V \rightarrow \mathbf{Z}$ is a k -weak-labelling of \mathbf{P} if it satisfies the following two conditions for every pair of elements $x, y \in \mathbf{P}$:

- 1 If $x < y$ then $f(x) < f(y)$
- 2 If $x \parallel y$ then $|f(x) - f(y)| \leq k$

The minimum value of k such that there exists a k -weak-labelling is called the *weak discrepancy* or \mathbf{P} and is denoted $wd(\mathbf{P})$.

The notion of weak discrepancy and the linear discrepancy were first described in the following two papers [6, 23]. The difference between the two is that the labelling of the poset for linear discrepancy must be an injective labelling, or simply a linear extension.

Definition 4. Let \mathbf{P} be a poset and L be a linear extension of \mathbf{P} . The *linear discrepancy of L* is the maximum difference in heights between two incomparable elements in L and is denoted $ld(\mathbf{P}, L)$. Thus, $ld(\mathbf{P}, L) = \max_{x \parallel y} |h_L(x) - h_L(y)|$. The *linear discrepancy of \mathbf{P}* is the minimum such value over all linear extensions and denoted $ld(\mathbf{P})$. Thus, $ld(\mathbf{P}) = \min_{L \in \varepsilon(\mathbf{P})} ld(\mathbf{P}, L)$

Thus, it is clear that the weak discrepancy of a poset is less than or equal to its linear discrepancy, and in fact this inequality is tight. As an example, a $\mathbf{1} + \mathbf{2d}$ has both linear discrepancy and weak discrepancy equal to d . In chapter 5 we give a necessary condition for equality and give the minimal posets for which this equality holds.

The next form of discrepancy is also very similar to weak discrepancy with the added restriction of having a limit on the number of copies for any particular label. This form of discrepancy is called t -discrepancy where t refers to the number of allowable copies and is denoted $d_t(\mathbf{P})$ for a poset \mathbf{P} . We give the formal definition below.

Definition 5. Let $\mathbf{P} = (V, \prec)$ be a poset and t be a positive integer. An integer-valued function $f : V \rightarrow \mathbf{Z}$ is called a (k, t) -labeling for \mathbf{P} if it satisfies the following three conditions for all $x, y, \in V$:

- (i) if $x \prec y$ then $f(x) < f(y)$,
- (ii) if $x \parallel y$ then $|f(x) - f(y)| \leq k$,
- (iii) $|f^{-1}(i)| \leq t$ for all $i \in \mathbf{Z}$.

Definition 6. If k is the least integer for which poset \mathbf{P} has a (k, t) -labeling, then we write $d_t(\mathbf{P}) = k$ and say that \mathbf{P} has t -discrepancy equal to k . A (k, t) -labeling f for which $k = d_t(\mathbf{P})$ is called a t -optimal labeling function (or just an *optimal* labeling function).

This version of discrepancy is really a hybrid of weak and linear as the larger the value for t the closer t -discrepancy is to weak discrepancy. Similarly, for small values of t the property is closer to linear discrepancy. In particular we have the following remark.

Remark 7. For and poset \mathbf{P} and any integer $t \geq 1$ we have $ld(\mathbf{P}) \geq d_t(\mathbf{P}) \geq wd(\mathbf{P})$.

The final definition of discrepancy measures the minimum average distance between incomparable pairs of a poset. This form of discrepancy is called total linear discrepancy.

Definition 8. Let $\mathbf{P} = (V, <)$ be a poset. The *total linear discrepancy of \mathbf{P}* is denoted by $tl(\mathbf{P})$ given by the following formula:

$$tl(\mathbf{P}) = \min_{L \in \mathcal{L}(\mathbf{P})} \sum_{x \parallel y} |h_L(x) - h_L(y)|$$

It should be noted and is straightforward to see that all forms of discrepancy are monotonic.

CHAPTER II

3-DISCREPANCY-IRREDUCIBLE POSETS OF WIDTH 2

Introduction The first result of this thesis deals with linear discrepancy. In a pair of papers [6, 23], the notion of linear discrepancy was introduced and a variety of results were proved about this property. In particular the linear discrepancy of the boolean lattice on $[n]$, where the relation between sets is by inclusion, was determined. Also, the paper showed that in general, determining a poset's linear discrepancy is in the class of NP-Complete problems. At the end of [23], a series of eight open questions was posed. The first of these questions was to characterize the set of posets whose linear discrepancy is two. The main proof of this chapter characterizes the set of posets whose linear discrepancy is two and whose width is two. In [12] the full characterization is ultimately proven.

In [23] they characterize the posets of linear discrepancy zero and one. Clearly, the only posets that have linear discrepancy zero are exactly those posets that have no pair of incomparable elements, specifically chains. The posets of linear discrepancy two are exactly the semiorders of width two. The proof is straightforward. First notice if there is ever an antichain of size three, then in any linear extension two points must be at distance at least two. Second notice that any poset with a $\mathbf{1} + \mathbf{3}$ or $\mathbf{2} + \mathbf{2}$ as a subposet must have linear discrepancy at least two. This shows that the set of posets with linear discrepancy one must be inside the class of semiorders of width two by Theorem 2. Finally, given any semiorder of width two, take the linear extension that orders points by left endpoint. The distance between any two incomparable points in this extension is exactly one, completing the proof.

In [3] the notion of k -discrepancy irreducibility was established in particular we

have the following definition.

Definition 9. A poset \mathbf{P} is *k-discrepancy-irreducible* if $ld(\mathbf{P}) = k$ and for every $x \in \mathbf{P}$ $ld(\mathbf{P} - x) < k$.

Also, Keller and Young have the following important lemma that helps to characterize posets of linear discrepancy k [17].

Lemma 10. *Let \mathbf{P} be a poset whose linear discrepancy is k . There exists a point $x \in \mathbf{P}$ such that $ld(\mathbf{P} - x) \geq k - 1$.*

With this definition and lemma in place, characterizing the posets of linear discrepancy k are those posets who do not have any $k + 1$ -discrepancy-irreducible poset as a subposet and must have a k -discrepancy-irreducible poset as a subposet. As just explained, the posets with linear discrepancy one are the class of semiorders of width two. Instead, this can be reworded as: a poset with linear discrepancy two must have a 1-discrepancy irreducible poset (a two element antichain) and cannot contain a 2-discrepancy-irreducible poset ($\mathbf{3} + \mathbf{1}$, $\mathbf{2} + \mathbf{2}$, $\mathbf{1} + \mathbf{1} + \mathbf{1}$). We use this framework to characterize those posets of linear discrepancy two.

The central idea of the chapter's main proof is that a width two 3-discrepancy-irreducible poset *almost* has linear discrepancy 2 and the subposet obtained by a removal of a specific maximal point *barely* has linear discrepancy 2. Formally, in a 3-discrepancy-irreducible poset, there is a linear extension that has a specific pair of incomparable elements whose difference in heights is 3, but for all other incomparable elements the maximum distance is 2. On the other hand, with the removal of a specific maximal point from a 3-discrepancy-irreducible poset, this subposet has a unique linear extension that witnesses linear discrepancy 2.

In this chapter we prove Theorem 11 (the main theorem of the chapter) with an inductive proof in which the base case is non-trivial. The key result in the proof is Lemma 12, which states that 3-discrepancy-irreducible posets of width 2 other

than $\mathbf{2} + \mathbf{3}$ must have the minimal element of one chain being incomparable to the bottom 4 elements of the other chain (a $\mathbf{1} + \mathbf{4}$). This result serves as the basis on which to inductively build our unique linear extension, since a $\mathbf{1} + \mathbf{4}$ by itself has a unique linear extension that shows this subposet has linear discrepancy 2. It is this forcing property that gives rise to an inductive argument that will eventually lead to the proof of Theorem 18 on 3-discrepancy-irreducible posets with a specific maximal point removed. From Theorem 18 one can make an observation that this immediately implies the main result Theorem 11.

Theorem 11. *If P is a 3-discrepancy-irreducible poset of width 2, then either P is $\mathbf{2} + \mathbf{3}$ or is a member of the family \mathcal{J}_3^2 .*

The special family \mathcal{J}_3^2 will be described in the next section.

Please note for the entirety of this chapter, in the figures we have the following:

- A solid line refers to a cover in the poset.
- A dashed line refers to an order relation between elements.
- A thick dotted line refers to an incomparability between elements.

This differs from a Hasse diagram as it is unclear whether certain pairs of elements are comparable or incomparable and so there is no line connecting them.

2.1 *The infinite family \mathcal{J}_3^2*

We will denote by \mathbf{M}_{2n} ($n \geq 3$) a special member of \mathcal{J}_3^2 on $2n$ points and describe how the other members of the family on $2n$ points are obtained from \mathbf{M}_{2n} . Since $\text{width}(\mathbf{M}_{2n}) = 2$, we consider it as being made of two chains, which we will call L and R , with some comparisons added between the chains. The construction is dependent on the parity of n . For n even, L has n points and R has n points, while for n odd, L has $n + 2$ points and R has $n - 2$ points. Let the points of the chain

L be $a_1 < a_2 < \dots$ and the points of the chain R be $b_1 < b_2 < \dots$. The covering relations we then add to construct \mathbf{M}_{2n} are

$$a_3 < b_2 < a_5 < b_4 < \dots < b_{n-4} < a_{n-1} < b_{n-2} \quad \text{for } n \text{ even}$$

and

$$a_3 < b_2 < a_5 < b_4 < \dots < a_{n-2} < b_{n-3} < a_n \quad \text{for } n \text{ odd.}$$

Note that for $n = 3$, there are no covering relations added by this construction, so \mathbf{M}_6 is isomorphic to $\mathbf{5} + \mathbf{1}$. The construction of \mathbf{M}_{2n} is completed by adding all relations implied by transitivity after adding the covering relations above. For illustration, Figure 4 shows the posets \mathbf{M}_8 , \mathbf{M}_{10} , and \mathbf{M}_{12} .

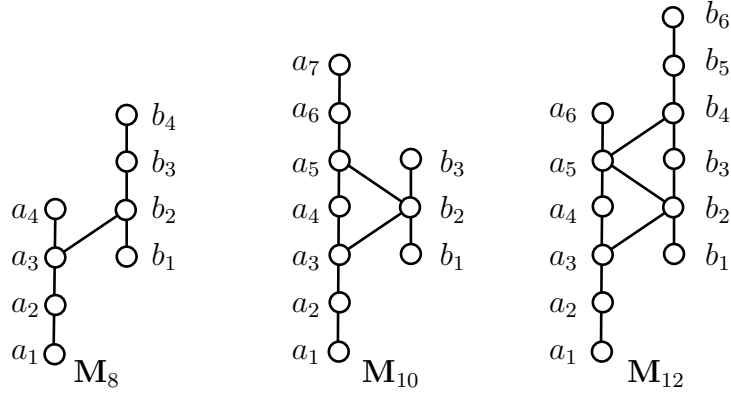

Figure 4: Three members of the infinite family \mathcal{J}_3^2

We obtain the remaining $2n$ -element members of \mathcal{J}_3^2 from \mathbf{M}_{2n} by removing any subset of the covering relations added above while retaining the comparabilities added due to transitivity. For example, Figure 5 shows the 3-irreducible poset of width 2 derived from \mathbf{M}_8 by removing the only possible covering relation and the 3-irreducible poset of width 2 derived from \mathbf{M}_{10} by removing the covering relation $a_3 < b_2$.

2.2 Proof of Theorem 11

For the remainder of this chapter, all posets are of width 2. Furthermore, we assume that these posets do not contain $\mathbf{2} + \mathbf{3}$ as a subposet.

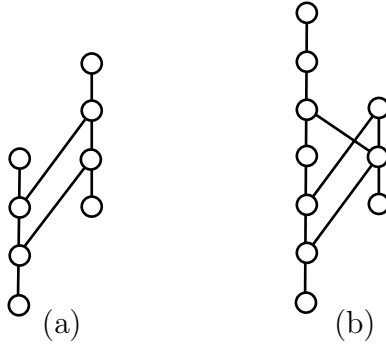

Figure 5: Members of the infinite family \mathcal{J}_3^2 derived from (a) \mathbf{M}_8 and (b) \mathbf{M}_{10}

We begin this section with a series of claims that proves some structure about 3-discrepancy-irreducible posets of width 2 that are not $\mathbf{2} + \mathbf{3}$. The purpose of these claims is to help prove the following key lemma.

Lemma 12. *A 3-discrepancy-irreducible poset of width 2 that is not $\mathbf{2} + \mathbf{3}$ must have one chain whose bottom 4 elements are incomparable to the minimum element of the other chain (an induced $\mathbf{1} + \mathbf{4}$).*

Remark 13. *The posets $\mathbf{2} + \mathbf{3}$ and the $\mathbf{1} + \mathbf{5}$ are 3-discrepancy-irreducible posets.*

Claim 14. *A 3-discrepancy-irreducible poset Q cannot be partitioned into two parts P and P' where every element of P is over every element of P' .*

Proof. Suppose the claim is false and there exists such a partition into P and P' . If Q were irreducible, then one could find linear extensions L_1 for P and L_2 for P' such that the distance between any incomparable elements in L_1 and L_2 is 2 or less. Placing L_1 on top of L_2 we have a linear extension of Q such that the distance between any two incomparable elements is at most 2, as no incomparabilities exist between P and P' . This is a contradiction, as Q was given as a poset with linear discrepancy 3. □

Claim 14 implies that a 3-discrepancy-irreducible poset of width 2 has a unique chain decomposition into 2 chains. Thus, we can refer to the chains as “left” and

“right” chains. Also, we will refer to the initial elements of the left chain as $[a_1, a_2, a_3 \dots]$ and the initial elements of the right chain as $[b_1, b_2, b_3, \dots]$.

Claim 15. *The smallest two elements in each of the two chains of a 3-discrepancy-irreducible poset of width 2 cannot form the poset shown in Figure 6.*

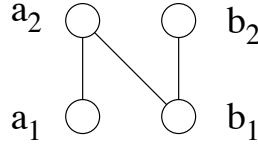

Figure 6: Forbidden minimal element structure

Proof. Suppose the claim is false and there exists a linear extension with b_1 removed so that the maximum distance between any 2 incomparable elements is less than 3. Note that any linear extension of linear discrepancy 2 must have a_1 at position 1 or 2 from the bottom of the extension. Otherwise b_2 would be in position 1 and a_2 would be in position 4 or higher, forcing the distance from a_2 to b_2 to be more than 2, a contradiction. Putting b_1 in position 0 gives a linear extension so that the maximum distance between any two incomparable elements is less than 3 for the original poset. This contradicts the fact that the linear discrepancy is 3. \square

Thus either $a_1, a_2, b_1,$ and b_2 form a $\mathbf{2} + \mathbf{2}$ or we have Figure 10, as Claim 14 and Claim 15 take care of the other two cases.

Claim 16. *If a 3-discrepancy-irreducible poset of width 2 is not $\mathbf{2} + \mathbf{3}$ then the smallest two elements in each of the two chains cannot form the poset $\mathbf{2} + \mathbf{2}$.*

Proof. Suppose otherwise. We separate into 2 cases as depicted in Figure 7 and Figure 9.

In the first case, one of the chains (without loss of generality, we will say the right chain) has only 2 elements as in Figure 7 (b_2 is the maximum element of the right chain). Then, by Claim 14, no element from the left chain can be above b_2 , and

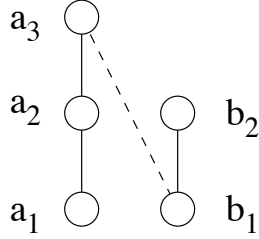

Figure 7: $\mathbf{2} + \mathbf{2}$ start with one chain being height 2 (not a $\mathbf{2} + \mathbf{3}$)

further, no element can be below b_2 in the left chain otherwise a_1 would be below b_2 violating the assumption of an initial $\mathbf{2} + \mathbf{2}$. Thus b_2 is incomparable to all elements in the left chain, and as $\mathbf{1} + \mathbf{5}$ is not a subposet, since it is 3-discrepancy-irreducible, there can be at most 4 elements in the left chain. Additionally, a_3 must be above b_1 ; otherwise, there would be a $\mathbf{2} + \mathbf{3}$ as a subposet. Under these restrictions we have the given poset in Figure 8, and as the labeling shows, this poset has linear discrepancy 2.

In the remaining case, each chain has at least 3 elements. As the poset does not

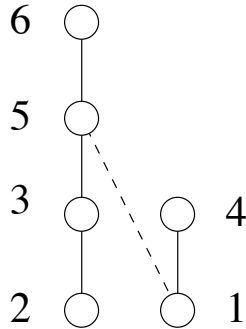

Figure 8: A 3-discrepancy-irreducible poset cannot begin as above.

contain a $\mathbf{2} + \mathbf{3}$, a_1 would be below b_3 and b_1 would be below a_3 as in Figure 9. Now by Claim 14, either b_3 must be incomparable to a_2 , or a_3 must be incomparable to b_2 . We may assume a_3 is incomparable to b_2 by the symmetry of the poset. Take a linear extension with b_1 removed so that the maximum distance between any two incomparable elements is less than 3. Note that the order $a_1 < b_2 < b_3$ is not a viable option, since the label for a_3 and b_2 would differ by more than 2. To show linear

discrepancy 2, the linear extension must be ordered:

(i.) (a_1, a_2, b_2, \dots)

(ii.) (a_1, b_2, a_2, \dots)

(iii.) (b_2, a_1, a_2, \dots)

For each case to keep the linear discrepancy at 2 (and hence arrive at a contradiction) with the addition of b_1 into the linear extension, do the following:

(i.) Let b_1 be the lowest element in the extension.

(ii.) and (iii.) Start the chain $a_1, b_1, b_2, a_2, \dots$ □

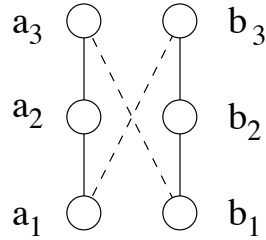

Figure 9: A forbidden beginning

If we assume that we have a 3-discrepancy-irreducible poset of width 2 that is not $\mathbf{1} + \mathbf{5}$ or $\mathbf{2} + \mathbf{3}$, by Claim 15 and Claim 16 we have the two least elements of each chain appear as in Figure 10. Combining this with Claim 14 we have Figure 11. Note that in Figure 11, we may assume b_1 is incomparable to a_1 , a_2 , and a_3 otherwise this would violate Claim 14. Also a_3 could be less than or incomparable to b_2 .

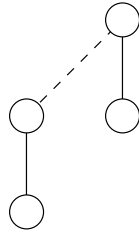

Figure 10: If the 3-discrepancy-irreducible poset is not $\mathbf{1} + \mathbf{5}$ or $\mathbf{2} + \mathbf{3}$, the smallest elements of the two chains must be in this configuration.

Claim 17. *If the 3-discrepancy-irreducible poset of width 2 begins as in Figure 11, then there must be a fourth element in the left chain.*

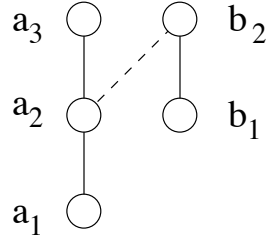

Figure 11: Since there is no unique maximum, we have this configuration.

Proof. Suppose the claim was false. Then a_3 must be incomparable to the right chain by Claim 14. In Figure 12, the position numbers for a linear extension have been given to show that the poset has linear discrepancy less than 3. If one were to add any more elements to the right chain, there would be a $\mathbf{1} + \mathbf{5}$ as a subposet, and thus the poset would not be irreducible. \square

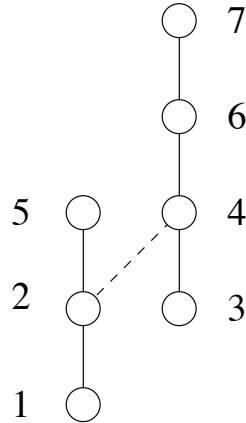

Figure 12: This shows there must be more than 3 elements in the left chain.

As previously stated, the previous 4 claims have been stepping stones to help prove Lemma 12 that will serve as the base case for inductively proving Theorem 18. We now have 4 elements in one chain and 2 in the other, and we have proven the following relations: b_1 is incomparable to a_1 , a_2 , and a_3 , and b_2 is over a_2 and not under a_3 . We now prove Lemma 12.

Proof. Suppose the lemma was false. If such a poset violated the lemma, it is not a $\mathbf{1} + \mathbf{5}$ as that agrees with the lemma. Thus, by our previous claims, we must be in

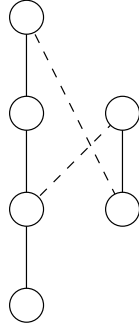

Figure 13: Supposing the 4th element in the left chain were comparable to the minimal element in right chain

the case of Figure 13. (Again it is possible for a_2 to be greater than b_3 , or a_4 greater than b_2 .)

Take a linear extension L with a_1 removed so that the maximum distance between any 2 incomparable elements is less than 3. Unless a_3 is below b_1 in L as in Figure 14(a), we can place a_1 at the bottom of the linear extension showing the original poset would have linear discrepancy 2. However, any extension with a_3 below b_1 , one can interchange a_3 and b_1 (as in Figure 14(b)) keeping the maximum distance between incomparable elements at 2 with the addition of a_1 . \square

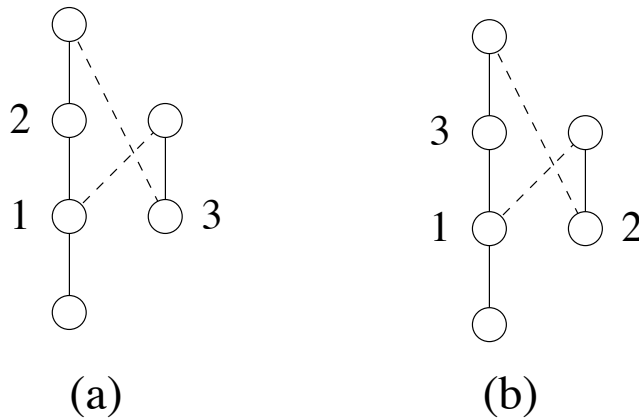

Figure 14: (a) A possible labeling leaving bottom element out. (b) A relabeling of (a)

From here on, we will assume that the left chain contains 4 elements at the bottom that are incomparable to the first element in the right chain. By considering the dual

of Lemma 12, a 3-discrepancy-irreducible poset must end with a $\mathbf{1} + \mathbf{4}$, though the 4-chain of the $\mathbf{1} + \mathbf{4}$ can occur on either the left or right chain. We will refer to the maximal element of this 4-chain as t .

For the next theorem, we will inductively construct a linear extension for a 3-discrepancy-irreducible poset with t removed. The theorem describes the very specific structure of such a reduced poset. It is this rigidity that forces there to be a unique linear extension that shows the reduced poset to have discrepancy 2.

Theorem 18. *Let P be a 3-discrepancy-irreducible poset of width 2 that is not $\mathbf{2} + \mathbf{3}$. There exists a maximal point in P whose removal leaves a poset with a unique linear extension witnessing linear discrepancy 2 (i.e. all other linear extensions will have a larger maximum distance between incomparable elements).*

In fact, we show that, the labeling of this extension must be as follows:

The two least elements of the left chain are labeled 1 and 2. The minimal element of the right chain is labeled 3. We then alternately label the two smallest unlabeled points from the left chain and the two smallest unlabeled points from the right chain until all elements (except t) have been labeled. (The poset's final 2 labeled elements will be from the same chain).

Furthermore, if v_i is the element with label i , then for all v_{2k+1} with $k \geq 2$, v_{2k+1} and the two elements immediately below v_{2k+1} in its chain are incomparable to v_{2k-1} (see Figure 15).

The unique maximal point stated in the theorem refers to element t . We must show that after labeling $2k + 1$ elements then either $P - t$ is completely labeled or there exist at least 2 more elements in the opposite chain that are incomparable to v_{2k+1} . Thus these additional two elements must be given labels $2k + 2$ and $2k + 3$.

Proof. For the element labeled 5, the work is already done since by Lemma 12 the poset must start with a $\mathbf{1} + \mathbf{4}$ and there is unique labeling of a poset with a $\mathbf{1} + \mathbf{4}$

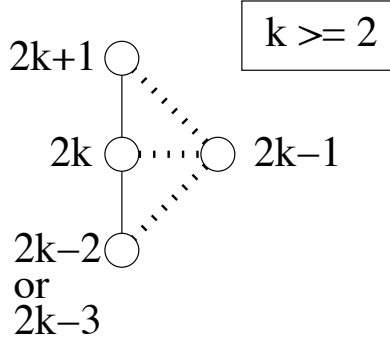

Figure 15: Induction structure and labeling

keeping the linear discrepancy at 2 (see Figure 16). Notice that element 5 and the two elements below it (the elements labeled 4 and 2) are incomparable to element 3.

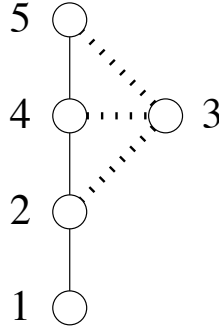

Figure 16: The base case

At the inductive step we assume we have partially completed the labeling as in Figure 15.

Inductive step: If t is the element above v_{2k+1} in P there can be no element above v_{2k-1} as this would produce a $\mathbf{2} + \mathbf{3}$. Note that if an element were above v_{2k-1} it would have to be incomparable with the last four elements of the left chain by the dual of Lemma 12. Thus we must be done with the labeling (by the dual of Lemma 12) as we will have a $\mathbf{1} + \mathbf{4}$ with t and the 3 elements below as the 4-chain and the 1-chain will be v_{2k-1} . If we are not done then there are two cases:

The first case is that there are no elements above element v_{2k+1} in the chain. We note that any element under v_{2k-1} (if one exists) must be less than v_{2k+1} otherwise

the poset would have linear discrepancy 3. Thus as v_{2k+1} is the maximum of one of the chains (and t is not above it) there must be two more elements above v_{2k-1} that are incomparable to v_{2k+1} by the dual of Lemma 12. Furthermore, they are labeled $2k + 2$ and $2k + 3$ and exhaust the right chain as shown in Figure 17.

In the second case (the remainder of the proof), there is an element above v_{2k+1}

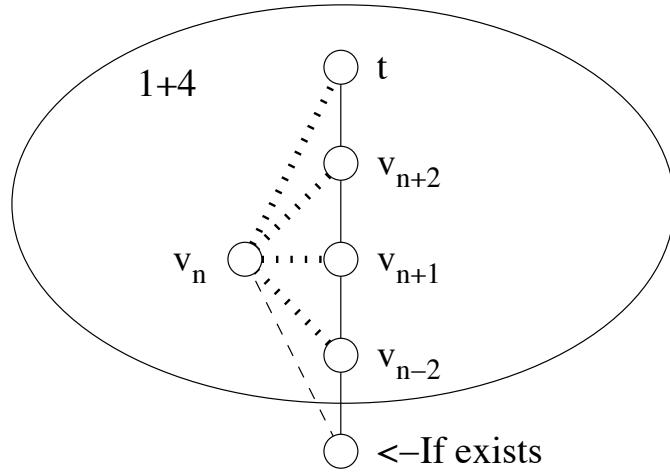

Figure 17: If t is above elements with label $2k + 3$

in the chain (that is not t). This point must be comparable to v_{2k-1} , otherwise the linear discrepancy would be greater than 2. This forces there to be another element above v_{2k-1} by Claim 14, since otherwise there would be a unique maximum element. Call this element v' . Then v' must be incomparable to v_{2k+1} as otherwise we would violate Claim 14. (See Figure 18).

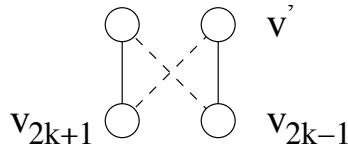

Figure 18: This forbidden poset shows v' is incomparable to v_{2k+1} .

We claim that v' is not the maximal element of a chain in P . To see why, suppose that v' is maximal. First notice that the element below v_{2k} must be under v' since v' would have label at least $2k + 2$, and any element with label less than $2k$ must be

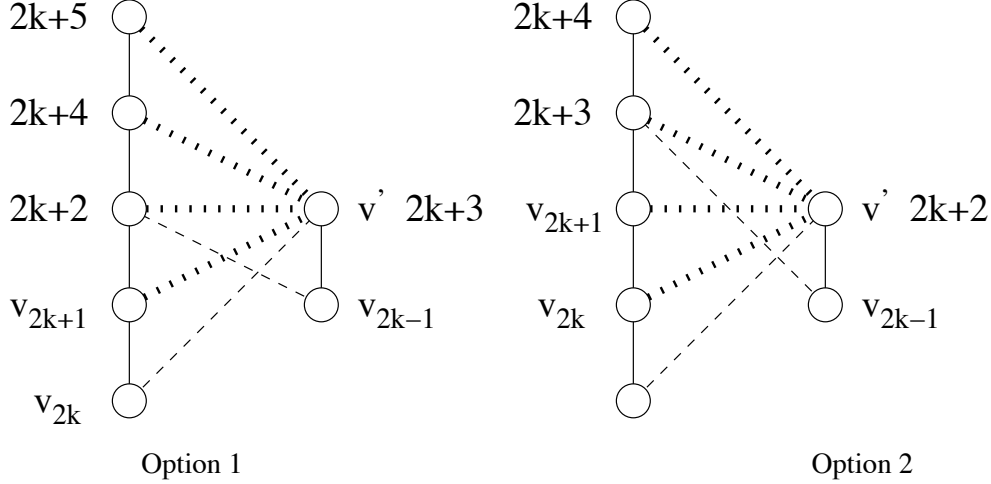

Figure 19: The two options if v' were to be the last element in a chain

comparable to v' . Now add back the element t to the poset. (The poset should again have linear discrepancy 3). By the dual of Lemma 12, the irreducible poset must end with a $\mathbf{1} + \mathbf{4}$, and thus we have two cases described by Figure 19. In both cases the given labeling will produce a linear extension where the maximum distance between any 2 incomparable elements is less than 3, a contradiction.

To summarize, what remains is the case where in one chain there is an element above v_{2k+1} that is greater than v_{2k-1} . In the other chain there is an element v' above v_{2k-1} and an element above v' which we will denote v'' (notice that v'' cannot be t). Also we have that v' is incomparable to v_{2k+1} .

If v'' is incomparable to v_{2k+1} , v' and v'' must be labeled $2k + 2$ and $2k + 3$ respectively, otherwise v'' will have a label bigger than $2k + 3$, causing $P - t$ to have linear discrepancy greater than 2. This will complete the induction as v_{2k+3} and the 2 elements below it will be incomparable to v_{2k+1} .

Thus, suppose v'' is comparable to, and therefore greater than, v_{2k+1} in the poset as seen in Figure 20. Now the original poset P should have linear discrepancy 3. Consider the subposet given by v_{2k} and v_{2k-1} and those elements above them. This

poset has linear discrepancy 2. Take a linear extension of this poset, and it must begin in one of the following four ways.

- (i.) $(v_{2k}, v_{2k+1}, v_{2k-1}, v', \dots)$
- (ii.) $(v_{2k}, v_{2k-1}, v', v_{2k+1}, \dots)$
- (iii.) $(v_{2k}, v_{2k-1}, v_{2k+1}, \dots)$
- (iv.) $(v_{2k-1}, v_{2k}, v_{2k+1}, \dots)$

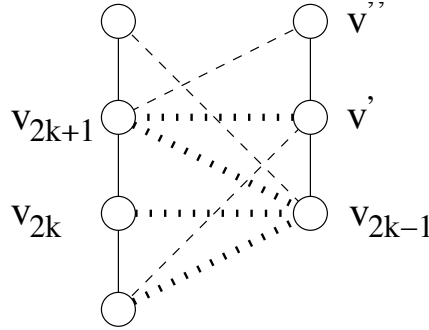

Figure 20: Supposing v'' were comparable to v_{2k+1}

Note that the labeling in case (i.) can be altered to that of case (iii.) without increasing the maximum distance between any two incomparable elements. Additionally, case (ii.) and case (iii.) can be altered to case iv again without increasing the maximum distance between two incomparable elements. In case (iv.), we can append our labeling to that which we produced inductively, giving us a labeling of the 3-discrepancy-irreducible poset with the maximum distance between any 2 incomparable elements less than 3, a contradiction. \square

As a result of this theorem, we can make an observation about 3-discrepancy-irreducible posets that are not $\mathbf{2} + \mathbf{3}$.

Theorem 18 nearly completely characterizes 3-discrepancy-irreducible posets of width 2 that are not $\mathbf{2} + \mathbf{3}$. In the following observation, we use the labeling of Theorem 18 to refer to the elements of these posets and fill in the remaining comparabilities.

Observation 19. *Labeling the points of a 3-discrepancy-irreducible poset as in Theorem 18, we have two properties. First, we must have an even number of elements in these posets. Second, any pair of elements whose labels differ by more than 3 must be comparable (the larger labeled element being over the smaller one).*

One notices that we have nearly completely characterized 3-discrepancy-irreducible posets of width 2 that are not $\mathbf{2} + \mathbf{3}$ by Theorem 18 and Observation 19. The only remaining observation we must make is how consecutive even labeled elements relate (except element labeled 2 who is always under element labeled 4). As we already have a forced unique linear extension that witnesses linear discrepancy 2 (with t removed), it is clear that the relation between consecutive even elements does not affect the linear discrepancy. Thus consecutive evens (other than 2) can be comparable (the higher labeled even element over the lower one) or incomparable.

Observation 20. *The 3-discrepancy-irreducible posets that are characterized by Theorem 18 and Observation 19 are exactly the members infinite family \mathcal{J}_3^2 .*

We leave Observation 20 to the reader thus concluding the proof of Theorem 11, though we make one note. The subset of these 3-discrepancy-irreducible posets whose consecutive even labeled elements are all comparable is the set $\{\mathbf{M}_{2n} : n \geq 3\}$ as described in §2.1. Also, we have provided the four 3-discrepancy-irreducible posets on 10 points with the forced labeling in Figure 21 to help see the observation.

2.3 Conclusion

As stated in the introduction the full characterization of 3-discrepancy-irreducible posets has been proven in [12]. The characterization states that with four exceptions all of the 3-discrepancy-irreducible posets of width three arise from removing particular comparabilities from posets in \mathcal{J}_3^2 or $\mathbf{2} + \mathbf{3}$. These exceptions are given in Figure 23.

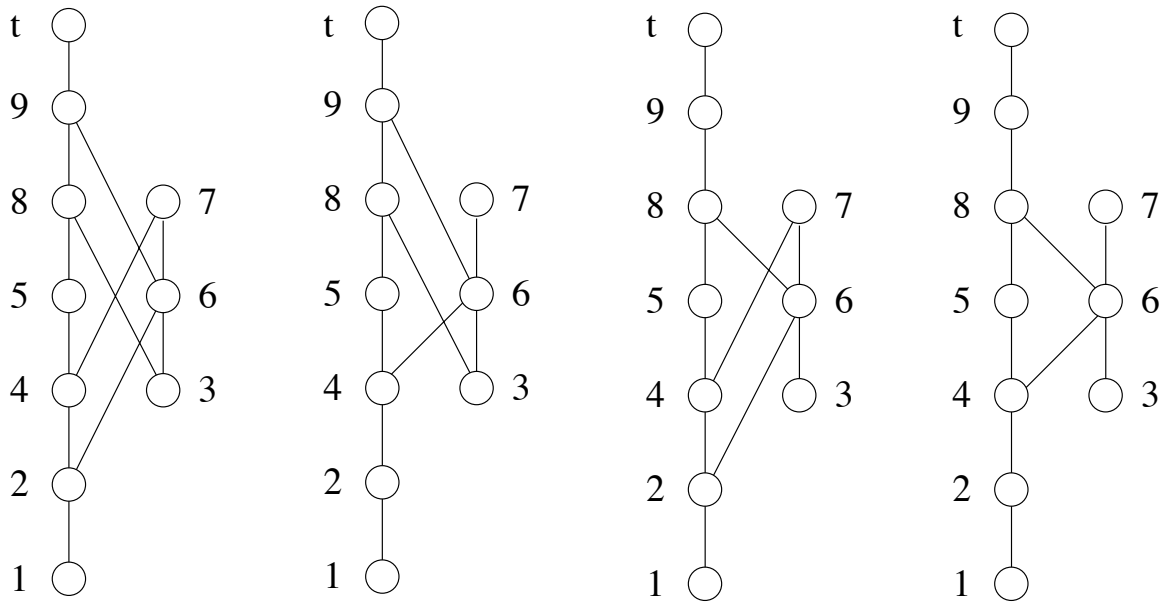

Figure 21: The four 3-discrepancy-irreducible posets on 10 points with the forced labeling excluding t

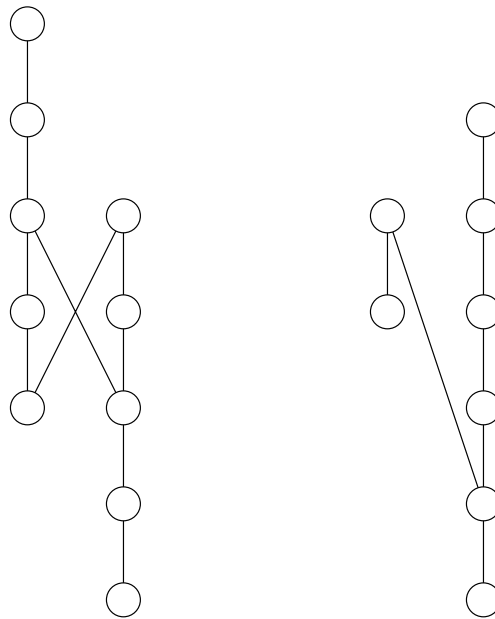

Figure 22: 2 examples of 4-discrepancy-irreducible posets

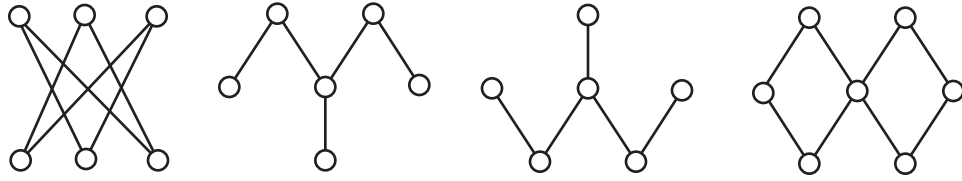

Figure 23: List of Exceptional 3-discrepancy-irreducible posets of width 3

The central idea of the proof involves reducing a 3-discrepancy-irreducible poset of width three to a 3-discrepancy-irreducible poset of width two by adding particular relations. The proof shows that unless the poset is one of the four notable exceptions on width three one can always add a relation among antichains of size 3 and keep the discrepancy fixed. Thus, it is enough to show which comparabilities among the members of \mathcal{J}_3^2 can be removed to complete the characterization.

Originally it was conjectured that the list of 3-discrepancy-irreducible posets was a small and finite list, surprisingly this turns out not to be the case although the posets that generate this list are easily described. Furthermore, it may be possible to determine similar results for higher linear discrepancy fixing the width at 2. At first glance, however, it seems that the problem with characterizing higher linear discrepancy valued posets would lead to a more difficult inductive proof. The posets in Figure 22 are 4-discrepancy-irreducible (we leave this to the reader to prove), however we point out that the induced starting structure differs. In one of the examples, there is an initial induced $\mathbf{1} + \mathbf{6}$, while the other begins with an induced $\mathbf{2} + \mathbf{4}$, and in some sense these structures are what is forcing the linear discrepancy of the poset higher. For higher linear discrepancies, Lemma 12 would need to be in some sense strengthened as the starting points would not necessarily have to be in such a binding structure.

CHAPTER III

t-DISCREPANCY

3.1 *Introduction*

The motivation for t -discrepancy was to find the fairest order of seeing patients in a hospital. Clearly, it is more important to see a patient who has been involved in a car accident over a patient that has a sinus infection; however, it is unclear if a patient who has back pain or one who has shoulder pain should be seen first. As an added factor there is a particular number of doctors t that staff a triage. Thus, the goal is to find an ordering that keeps patients that are incomparable together. Additionally, t people can be seen at the same time. An optimal order in which incomparable patients would be seen as close together as possible would be answering the question about finding a linear extension that witnesses a poset's t -discrepancy.

This chapter surveys a variety of results for this property. It begins with giving some elementary results such as the t -discrepancy of an antichain and properties that you can assume when searching for an optimal labeling. Following this there is a proof that t -discrepancy is not a comparability invariant. This means that there exist posets that share a comparability graph but have different t -discrepancy values. This is rather surprising as linear discrepancy and weak discrepancy have this property; however, t -discrepancy as a hybrid of the two does not.

The final sections survey three more ideas. First, some common poset's t -discrepancies are determined, including the disjoint sum of chains and the standard example posets. Then, a proof is given that determining t -discrepancy is NP-Complete for poset's in general. Finally, the t -discrepancy of semiorders is determined to take a polynomial

amount of time to find. In fact, knowing the width of a semiorder forces the t -discrepancy to be at most one of two values. The algorithm given in the final section computes the t -discrepancy of a semiorder in $O(n^4 \log n)$ complexity, where n is the size of the poset.

3.2 *Elementary Results*

It is often convenient to have a (k, t) -labeling of poset P that satisfies one or both of the following properties.

- (a) The minimum value of f is a specified integer m .
- (b) There is no integer gap in the range of f .

We say that a (k, t) -labeling of P is *gap-free* if it satisfies property (b) and prove in Lemma 21 that every (k, t) -labeling of P can be transformed into a gap-free (k, t) -labeling of P with any specified minimum value.

Lemma 21. *Let m be any integer. If poset $P = (V, \prec)$ has a (k, t) -labeling then it has a gap-free (k, t) -labeling with minimum value m .*

Proof. Suppose f is a (k, t) -labeling of P . Adding a constant to every function value yields another (k, t) -labeling of P . Thus we may assume the minimum value of a (k, t) -labeling is m . Let M be the maximum value attained, and suppose there exists a gap in the labeling, that is, an integer i with $m < i < M$ so that $f(v) \neq i$ for all $v \in V$. Define a new function $g : V \rightarrow \mathbf{Z}$ with $g(v) = f(v)$ for all v with $f(v) < i$ and $g(v) = f(v) - 1$ for all v with $f(v) > i$.

Then $|g(x) - g(y)| \leq |f(x) - f(y)|$ for any pair of points $x, y \in V$ and it is easy to check that g is also (k, t) -labeling of P . Repeat this process if necessary until no gaps remain. □

Any gap-free (k, t) -labeling of a poset $P = (V, \prec)$ with minimum value $m = 1$ has maximum value $M \leq |V|$, and thus we have the following remark.

Remark 22. For any poset $P = (V, \prec)$ and any integer $t \geq 1$ we have $d_t(P) \leq |V| - 1$.

We collect several additional elementary results which we will need later. The next remark follows because any (k, t) -labeling of a poset induces a (k, t) -labeling on any subposet.

Remark 23. If P is an induced subposet of Q , then $d_t(P) \leq d_t(Q)$.

Lemma 24. If A is an antichain, then $d_t(A) = \left\lceil \frac{|A|}{t} \right\rceil - 1$.

Proof. The labeling function in which t points get label 1, t points get label 2, and so on is t -optimal. The largest label used is $\left\lceil \frac{|A|}{t} \right\rceil$, the smallest is 1, and thus $d_t(A) = \left\lceil \frac{|A|}{t} \right\rceil - 1$. \square

3.3 Comparability Invariance

The *comparability graph* of a poset $P = (V, \prec)$ is the graph $G = (V, E)$ where $xy \in E$ if and only if x and y are comparable in P . A parameter π defined for posets is said to be a *comparability invariant* if for all posets P and Q , we have $\pi(P) = \pi(Q)$ whenever the comparability graphs of P and Q are isomorphic. Some well-known poset parameters, such as dimension, are known to be comparability invariants (see [25]). Weak discrepancy is shown to be a comparability invariant in [8] and linear discrepancy is shown to be a comparability invariant in [23]. The latter also follows from the main result in [6] that all posets P satisfy

$$ld(P) = bandwidth(\overline{G}) \tag{1}$$

where \overline{G} is the incomparability graph of P , that is, the complement of the comparability graph of P .

Surprisingly, for all integers $t > 1$, t -discrepancy is *not* a comparability invariant even though we think of t -discrepancy as lying between linear and weak discrepancy. This is proven below in Theorem 25.

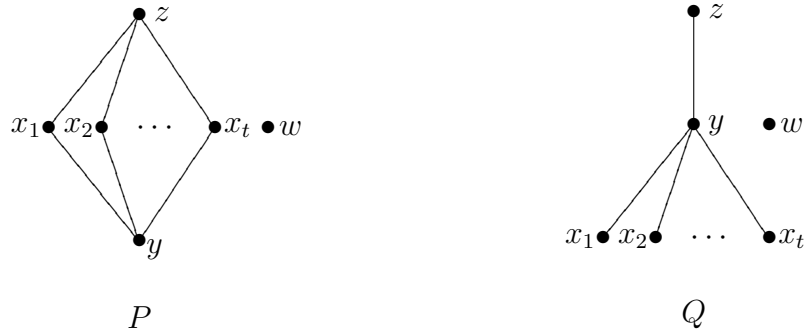

Figure 24: Two posets with the same comparability graph but with different t -discrepancy.

Theorem 25. *For any integer $t > 1$ there exist posets P and Q that have the same comparability graph, but for which $d_t(P) \neq d_t(Q)$. Thus t -discrepancy is not a comparability invariant.*

Proof. Fix an integer $t > 1$ and consider the posets P and Q shown in Figure 24. It is easy to check that P and Q have the same set of comparabilities; thus they have the same comparability graph. We next show $d_t(Q) = 1$ and $d_t(P) = 2$.

Since Q has an antichain of size $t + 1$, Remark 23 and Lemma 24 imply that $d_t(Q) \geq 1$. The function f defined by $f(x_i) = 1$ for $1 \leq i \leq t$, $f(y) = f(w) = 2$, $f(z) = 3$ is a $(1, t)$ -labeling for Q , thus $d_t(Q) \leq 1$. Together these imply that $d_t(Q) = 1$.

Next we show $d_t(P) > 1$. Suppose, for a contradiction, that $d_t(P) \leq 1$ and let f be a $(1, t)$ -labeling for P . Without loss of generality, we may assume $f(y) = 0$, and since $w \parallel y$ we have $f(w) \leq 1$ by (ii) of Definition 5.

If there exist $1 \leq i, j \leq t$ with $f(x_i) < f(x_j)$, then since $y \prec x_i$ and $x_j \prec z$, using Definition 5 we have $f(x_i) \geq 1$, $f(x_j) \geq 2$ and $f(z) \geq 3$. However, $w \parallel z$ and $|f(z) - f(w)| \geq f(z) - f(w) \geq 3 - 1 = 2$ which contradicts (ii) of Definition 5. Otherwise, $f(x_i) = c$ for all $1 \leq i \leq t$, where $c \geq 1$ because $y \prec x_i$. Since $y \prec x_i \prec z$ and $f(y) = 0$, we know $f(z) \geq 2$ by (i) of Definition 5. If $f(w) \leq 0$, then $|f(z) - f(w)| \geq f(z) - f(w) \geq 2 - 0 = 2$ violating (ii) of Definition 5. If $f(w) = 1$,



Figure 25: The posets S_3 and S_4 together with 2-optimal labelings of them.

then $c \geq 2$ and $f(z) \geq 3$, so $|f(z) - f(w)| \geq f(z) - f(w) \geq 3 - 1 = 2$ again violating (ii) of Definition 5. Thus $d_t(P) > 1$. Indeed, the function f defined by $f(y) = 0$, $f(x_i) = 1$ for $1 \leq i \leq t$, $f(w) = 2$, and $f(z) = 3$ is a $(2, t)$ -labeling function; thus $d_t(P) = 2$. \square

As a consequence of Theorem 25, we know there is no result analogous to equation (1) that relates the t -discrepancy of a poset to a parameter of its incomparability graph.

3.4 Special Classes of Posets

In this section we find $d_t(P)$ for two special classes of posets, the standard examples of posets of dimension n and the disjoint sum of chains.

Let $n \geq 3$ be an integer. The poset $S_n = (X, \prec)$ is called the *standard example* of a poset of dimension n . It has as its ground set $X = \{a_1, a_2, \dots, a_n\} \cup \{b_1, b_2, \dots, b_n\}$, and the only comparabilities are $a_i \prec b_j$ for $i \neq j$. Figure 25 shows the posets S_3 and S_4 together with 2-optimal labelings of them. According to Theorem 26, we have $d_2(S_3) = 2$ and $d_2(S_4) = 2$.

Theorem 26. *Let S_n be the standard example of a poset of dimension n and let t be an integer $t \geq 2$, then $d_t(S_n) = \lceil n/t \rceil$.*

Proof. Let S_n have ground set $\{a_1, a_2, \dots, a_n, b_1, b_2, \dots, b_n\}$ where the a_i are minimal, the b_i are maximal, $a_i \parallel b_i$ for each i and $a_i \prec b_j$ for each $i \neq j$. Write $n = qt + a$ where q is an integer and $0 < a \leq t$. Thus we seek to show $d_t(S_n) = q + 1$.

First we construct a $(q + 1, t)$ -labeling f of S_n , showing $d_t(S_n) \leq q + 1$. Label the minimal elements using the labels $1, 2, 3, \dots, q + 1$. There will be sufficient labels since $n \leq (q + 1)t$. Let $f(b_i) = f(a_i) + q + 1$. This function f is a $(q + 1, t)$ -labeling of S_n , thus $d_t(S_n) \leq q + 1 = \lceil n/t \rceil$.

For the reverse inequality, let f be a t -optimal labeling of S_n . By Lemma 24. the antichain A of minimal elements has $d_t(A) = \lceil n/t \rceil - 1 = q$. If $d_t(A_f) \geq q + 1$ then $d_t(S_n) \geq q + 1$ and we are done. So instead we may assume $d_t(A_f) = q$. The antichain A of minimal elements requires at least $q + 1$ labels and they must be consecutive to achieve $d_t(A_f) = q$, so without loss of generality we may assume $f(a_1) = 1$ and $f(a_n) = q + 1$. Since $a_n \prec b_1$ we must have $f(b_1) \geq q + 2$ and then $|f(b_1) - f(a_1)| \geq q + 1$. Since f was assumed to be t -optimal, we know $d_t(S_n) \geq q + 1$. □

Next we consider the t -discrepancy of the disjoint sum of chains. Figure 26 illustrates three examples. In each, we think of the points as fitting on a rectangular grid where the height (i.e., y -coordinate) of a point is the value of the label assigned to it. The width of the grid is t since each label can occur at most t times. The grid must be tall enough to accommodate both the biggest chain in the poset and also the total number of points in the poset. Whichever of these factors is more limiting determines the part of the formula for $d_t(P)$ in Theorem 27 that applies.

Theorem 27. *Let $P = \mathbf{r}_1 + \mathbf{r}_2 + \dots + \mathbf{r}_p$ where $r_1 \geq r_2 \geq \dots \geq r_p$, and let $t \geq 2$ be an integer. Furthermore, let $s = r_1 + r_2 + \dots + r_p$, let $s' = r_2 + \dots + r_p$, let $q = \lceil \frac{s}{t} \rceil$, let $q' = \lceil \frac{s'}{t-1} \rceil$ and let $M = \max\{r_2, q'\}$. Then*

$$d_t(P) = \begin{cases} q - 1, & \text{if } q > r_1 \\ \lceil (r_1 + M)/2 \rceil - 1, & \text{if } q \leq r_1. \end{cases}$$

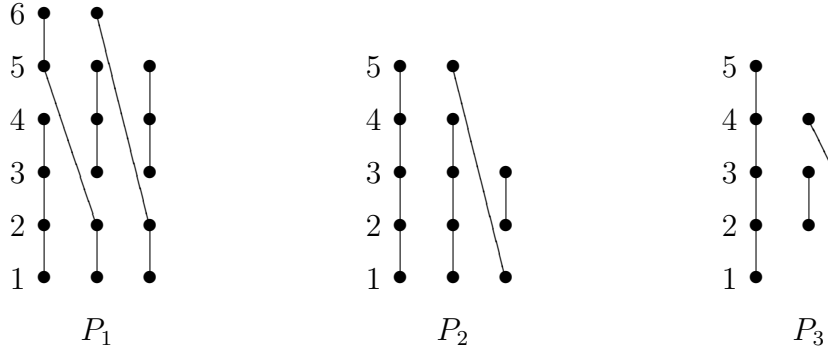

Figure 26: Optimal labeling functions for posets P_1, P_2, P_3 when $t = 3$. In each, the height of a point is the value of its label.

Before presenting the proof of Theorem 27, we illustrate the upper bound by giving a (k, t) -labeling for three examples.

Example 28. For all three posets in this example, we use $t = 3$, and thus the grids of points each have three columns.

For poset $P_1 = \mathbf{4} + \mathbf{4} + \mathbf{3} + \mathbf{3} + \mathbf{3}$ we have $s = 17$, $s' = 13$, $q = 6$, $q' = 7$, and $M = 7$, which falls in case 1 in the proof of Theorem 27. Here the height of the grid is determined by $q = 6 > 4 = r_1$. The labels assigned to \mathbf{r}_1 are 1, 2, 3, 4; to \mathbf{r}_2 are 5, 6, 1, 2; to \mathbf{r}_3 are 3, 4, 5; to \mathbf{r}_4 are 6, 1, 2; and to \mathbf{r}_5 are 3, 4, 5 as illustrated in Figure 26. Thus $d_t(P_1) \leq 5$.

For poset $P_2 = \mathbf{5} + \mathbf{4} + \mathbf{2} + \mathbf{2}$ we have $s = 13$, $s' = 8$, $q = 5$, $q' = 4$, and $M = 4$, which falls in case 2a in the proof of Theorem 27. The height of the grid is determined by $r_1 = 5 \geq 5 = q$. The labels assigned to \mathbf{r}_1 are 1, 2, 3, 4, 5; to \mathbf{r}_2 are 1, 2, 3, 4; to \mathbf{r}_3 are 5, 1; to \mathbf{r}_4 are 2, 3 as illustrated in Figure 26. Thus $d_t(P_2) \leq 4$.

For poset $P_3 = \mathbf{5} + \mathbf{2} + \mathbf{2} + \mathbf{2}$ we have $s = 11$, $s' = 6$, $q = 4$, $q' = 3$, and $M = 3$, which falls in case 2b in the proof of Theorem 27. The height of the grid is determined by $r_1 = 5 \geq 4 = q$. The labels assigned to \mathbf{r}_1 are 1, 2, 3, 4, 5; to \mathbf{r}_2 are 2, 3; to \mathbf{r}_3 are 4, 2; to \mathbf{r}_4 are 3, 4 as illustrated in Figure 26. Thus $d_t(P_3) \leq 3$.

Proof of Theorem 27. We consider two cases depending on whether the range of

labels needed for P will be determined by the size of the largest chain or by the total number of points in P .

Case 1: $q > r_1$.

First we show the upper bound $d_t(P) \leq q - 1$. Form a sequence of qt labels consisting of the sequence $1, 2, 3, \dots, q$ repeated t times. Assign the first r_1 numbers in the sequence to be labels for the points in \mathbf{r}_1 , the next r_2 numbers in the sequence to be labels for the points in \mathbf{r}_2 , etc. In assigning labels to the points in \mathbf{r}_i , follow rule (i) of Definition 5. This is illustrated in the labeling of poset P_1 in Figure 26 as detailed in Example 28. By the definition of $q = \lceil s/t \rceil$, there are sufficient labels. In this case, $r_i \leq r_1 < q$ for each i , and each chain \mathbf{r}_i is assigned r_i distinct labels, so the labeling is valid. The largest possible difference in label is $q - 1$, so $d_t(P) \leq q - 1$.

Next we show the lower bound $d_t(P) \geq q - 1$. For a contradiction, assume $d_t(P) \leq q - 2$ and using Lemma 21, let f be a gap-free, t -optimal labeling of P with minimum value $m = 1$. If $f(x) \leq q - 1$ for all points x in P , then there are at most $q - 1$ labels, each appearing at most t times, for a total of at most $(q - 1)t < s$ labels available. Thus there are not enough labels for all the points in P . Hence there must be a point of P with label at least q . For each label $\ell \geq q$ that appears, we can only have one point labeled $\ell - (q - 1)$, because two such points would be incomparable to each other and thus one of them would be incomparable to the point labeled ℓ , contradicting $d_t(P) \leq q - 2$. So for each point with label q or bigger we lose $t - 1 \geq 1$ potential labels for points. Thus there will not be sufficient labels to label the s points of P , a contradiction.

Case 2: $q \leq r_1$.

We begin by showing that

$$M \leq r_1. \tag{2}$$

Since $M = \max\{r_2, q'\}$ and we already know $r_2 \leq r_1$, it suffices to show $q' \leq r_1$. We know $r_1 \geq q = \lceil s/t \rceil \geq s/t$ and thus $r_1 t \geq s = s' + r_1$. Subtracting r_1 from both

sides yields $r_1(t-1) \geq s'$ or equivalently $r_1 \geq s'/(t-1)$. Since r_1 is an integer we have, $r_1 \geq \lceil s'/(t-1) \rceil = q'$ as desired.

Next we establish the upper bound $d_t(P) \leq \lceil (r_1 + M)/2 \rceil - 1$. We give a labeling of P as follows. Label the chain \mathbf{r}_1 using labels $1, 2, 3, \dots, r_1$. For the s' elements in the other chains, make $t-1$ copies of the sequence

$$\lceil (r_1 + M)/2 \rceil - M + 1, \lceil (r_1 + M)/2 \rceil - M + 2, \dots, \lceil (r_1 + M)/2 \rceil$$

for a total of $M(t-1)$ labels. Since $s' \leq q'(t-1) \leq M(t-1)$ we have sufficient labels. As before, assign the first r_2 elements of this sequence to the chain \mathbf{r}_2 , the next r_3 elements to be the labels for \mathbf{r}_3 , etc. This is illustrated in the labeling of posets P_2 and P_3 of Figure 26 as detailed in Example 28. For P_2 we have $M = r_2 = 4$ and for P_3 we have $M = q' = 3$. Since $r_i \leq r_2$ for each $i \geq 2$, each sequence \mathbf{r}_i is assigned r_i distinct labels, so the labeling is valid. Any two elements of $\mathbf{r}_2 + \mathbf{r}_3 + \dots + \mathbf{r}_p$ have labels that differ by at most $M-1$, and using equation (2) we have $M-1 \leq \lceil (r_1 + M)/2 \rceil - 1$. The largest difference in label between a point in \mathbf{r}_1 and a point in $\mathbf{r}_2 + \mathbf{r}_3 + \dots + \mathbf{r}_p$ will occur between the highest label in one and the lowest in the other, thus will be either $\lceil (r_1 + M)/2 \rceil - 1$ or $r_1 - (\lceil (r_1 + M)/2 \rceil - M + 1) \leq r_1 - (r_1 + M)/2 + M - 1 \leq \lceil (r_1 + M)/2 \rceil - 1$. Hence $d_t(P) \leq \lceil (r_1 + M)/2 \rceil - 1$ as desired.

For the lower bound $d_t(P) \geq \lceil (r_1 + M)/2 \rceil - 1$, we consider two subcases depending on whether $M = r_2$ or $M = q'$.

Subcase 2a: $q' \leq r_2 = M$. We first use a theorem from [23] which gives a formula for the weak discrepancy for sums of disjoint chains.

Theorem 29. *If $P = \mathbf{r}_1 + \mathbf{r}_2 + \dots + \mathbf{r}_p$ is the disjoint sum of p chains and $r_1 \geq r_2 \geq \dots \geq r_p$ then $wd(P) = \lceil \frac{r_1 + r_2}{2} \rceil - 1$.*

Using Theorem 29 and Remark 7 that says the t -discrepancy is bounded by weak discrepancy we conclude

$$d_t(P) \geq wd(P) = \lceil (r_1 + r_2)/2 \rceil - 1 = \lceil (r_1 + M)/2 \rceil - 1.$$

Subcase 2b: $r_2 < q' = M$.

We have already shown the upper bound $d_t(P) \leq \lceil (r_1 + M)/2 \rceil - 1$. Combining this with equation (2) yields

$$d_t(P) \leq r_1 - 1. \tag{3}$$

Let the points of the chain \mathbf{r}_1 be $b_1 \prec b_2 \prec \dots \prec b_{r_1}$. Let f be an t -optimal labeling of P with $f(b_1) = 1$ and $h = f(b_{r_1})$ as small as possible.

Claim: $h = r_1$.

We know $h \geq r_1$ to accommodate the r_1 points of the chain, so for a contradiction, assume $h \geq r_1 + 1$. Since every point in P' is incomparable to both b_1 and b_{r_1} , by equation (3), the labels 1 and h can not appear on points in P' . We will apply the following algorithm to point x with label $f(x) = c$. Initially, let $x = b_{r_1}$, thus $f(x) = c = h$. Lower x 's label by 1, that is, set $f(x) := c - 1$. Since we wish the resulting labeling to be t -optimal, three potential problems could arise, (i) a comparability problem – there is a point w with $w \prec x$ and $f(w) = c - 1$, (ii) an overcrowding problem – there are already t points with label $c - 1$, and (iii) an incomparability problem – there is a point z with $x \parallel z$ and $f(z) - c = d_t(P)$. We will show below that (iii) never occurs. In case (i), there can only be one such w since P is the sum of chains, and we then apply the algorithm to w . Since w 's label will be lowered by 1, this also resolves any overcrowding problem at label $c - 1$ which may arise simultaneously. If there is no comparability problem, but there is an overcrowding problem, we find another point y in P' with $f(y) = c - 1$ and apply the algorithm to y . Note that such a y will exist since $t \geq 2$. When no problems occur, the algorithm terminates.

Next we describe how the algorithm progresses and show it will terminate with all labels between 1 and $h - 1$. The algorithm will stop at or before reaching a point with label 1, since we've already shown that there is exactly one point (b_1) with label 1 in P . By our assumption that $f(b_1) = 1$ and $f(b_{r_1}) = h \geq r_1 + 1$, we know the labels of points in \mathbf{r}_1 are not consecutive and hence there are one or more gaps. The algorithm starts at b_{r_1} and continues considering points down \mathbf{r}_1 resolving comparability problems (i) until the first gap in labels is reached. If there is no overcrowding problem, the algorithm terminates. If there is an overcrowding problem, then from this point on, the algorithm is only applied to points in P' , each of which has label at least 2. Either the algorithm stops before reaching a point in P' with label 2 or if one is reached, its label can be lowered to 1 without causing any problems since b_1 is the only point with label 1 and no points have label 0.

Finally, we show that an incomparability problem never occurs. It can not occur when considering x in \mathbf{r}_1 since such an x has $f(x) \geq 2$ and has the same incomparabilities as b_1 with $f(b_1) = 1$. Likewise, it will not occur when considering x in P' . Any $x \in P'$ is incomparable to b_{r_1} , and so $f(b_{r_1}) - f(x) = h - f(x) \leq d_t(P)$. Initially, b_{r_1} is the only point in P with label h , and after the first pass of the algorithm, all points in P have labels at most $h - 1$. Thus for any point z with $x \parallel z$ we have $f(z) - f(x) \leq h - 1 - f(x) \leq d_t(P) - 1$ and so an incomparability problem never occurs for $x \in P'$.

When the algorithm terminates, none of the potential problems (i), (ii), (iii) occur and thus the resulting labeling is still t -optimal. However, we have contradicted the minimality of h . This justifies our claim that $h = r_1$.

Now we know there exists a t -optimal labeling of P in which the points in the chain \mathbf{r}_1 are labeled $1, 2, 3, \dots, r_1$. Let m_2 be the largest label that appears in P' and m_1 be the minimum such label. We know $1 \leq m_1$ and $m_2 \leq r_1$ by equation (3). We also know $q' - 1 \leq m_2 - m_1$ in order to have enough labels to accommodate the

points in P' . Thus $d_t(P) = \max\{r_1 - m_1, m_2 - 1\}$. If these two quantities differ by 2 or more, we could add one to each label in P' (if the first is larger) or subtract one from each label in P' (if the second is larger) to get a smaller value of $d_t(P)$. Thus $|(r_1 - m_1) - (m_2 - 1)| \leq 1$ and

$$d_t(P) = \max\{r_1 - m_1, m_2 - 1\} = \left\lceil \frac{(r_1 - m_1) + (m_2 - 1)}{2} \right\rceil \geq \left\lceil \frac{r_1 + q' - 2}{2} \right\rceil$$

and so $d_t(P) \geq \left\lceil \frac{r_1 + q'}{2} \right\rceil - 1$ as desired. \square

3.5 Computing $d_t(P)$ is NP-Complete

In this section we show that the problem of deciding whether a poset $P = (V, \prec)$ has a (k, t) -labeling is NP-complete. We accomplish this by constructing its t -duplicated poset $P' = (V', \prec')$ as follows. Let V' consist of t points v_1, v_2, \dots, v_t for each $v \in V$. For each $x, y \in V$ and each $i, j \in \{1, 2, \dots, t\}$ we have $x_i \prec' y_j$ if and only if $x \prec y$ in P . Thus each point of P is replaced by an antichain of t points in P' . We call this antichain the *cluster* corresponding to the point $v \in V$. Figure 27 shows a poset P and its 3-duplicated poset P' .

Suppose g is a (k, t) -labeling function for the t -duplicated poset P' . If C_v is the cluster of points in P' corresponding to $v \in V$ we define $\min(C_v) = \min\{g(v_i) : v_i \in C_v\}$ and $\max(C_v) = \max\{g(v_i) : v_i \in C_v\}$. A cluster C_v is *uniform* if $\max(C_v) = \min(C_v)$.

The next remark follows because two points in a cluster together have the same comparabilities and incomparabilities.

Remark 30. *Let g be a (k, t) -labeling of the t -duplicated poset P' in which points v_i and v_j are in the same cluster. If there are fewer than t points with label $g(v_j)$ then setting the value of $g(v_i)$ to equal that of $g(v_j)$ also results in a (k, t) -labeling of P' .*

Theorem 31. *Let $P = (V, \prec)$ be a poset and t, k be positive integers. The decision problem $d_t(P) \leq k$ is NP-complete.*



Figure 27: A poset P and its 3-duplicated poset P' .

Proof. Construct the t -duplicated poset P' from P . We will show that $d_t(P') = ld(P)$. The result in Theorem 31 then follows since the decision problem $ld(P) \leq k$ is NP-complete [6] and constructing P' from P can be accomplished in polynomial time.

Recall from Definition 6 from chapter 1 that $d_t(P_f)$ measures the maximum difference in function values between pairs of incomparable points for the (k, t) -labeling f . In the case $t = 1$, t -discrepancy is linear discrepancy and we denote $d_1(P_f)$ by $ld(P_f)$.

First we show $d_t(P') \leq ld(P)$. Let $k = ld(P)$ and take an optimal 1-labeling of P . We obtain a (k, t) -labeling g of P' by setting $g(x_i) = f(x)$ for each $x \in V$ and $i = 1, 2, \dots, t$.

Next we show the reverse inequality $ld(P) \leq d_t(P')$. If there exists a (k, t) -labeling g of P' in which all clusters are uniform, we immediately obtain a 1-labeling f of P , namely $f(v) = g(v_1)$ for each $v \in V$, with $d_t(P'_g) = ld(P_f)$. When g is t -optimal, we have $ld(P) \leq ld(P_f) = d_t(P'_g) = d_t(P')$ as desired.

Otherwise, let j be the maximum so that P' has an t -optimal labeling g in which the points labeled i are in a cluster together for $i = 1, 2, 3, \dots, j - 1$. By our assumption, $j \leq |V|$. We will show that we can swap some labels to arrive at a (k, t) -labeling g' of P' so that points labeled i are in a cluster together for $i = 1, 2, 3, \dots, j$, contradicting the maximality of j .

By Remark 30, we can make the clusters containing the points with labels less than j into uniform clusters and still have a t -optimal labeling. Since all points with

labels less than j are in uniform clusters, these clusters include all such points. Thus any point with label j is in a cluster with other points whose labels are at least j . If, in fact, the points labeled j are now all in a cluster together, we violate the maximality of j . Thus we may assume there are at least two clusters containing points with label j . Among all such clusters choose one C_v for which $\max(C_v)$ is largest and another, C_w for which $\max(C_w)$ is smallest. If there are r points in C_v with label j then at most $t - r$ points in C_w have label j , and thus at least r points in C_w have a label greater than j . For each point in C_v with label j , switch its label with that of a point in C_w whose label is greater than j . Note that this new labeling of P' is still t -optimal since all points in a cluster have the same set of incomparabilities. Yet the new labeling has one fewer cluster containing a point with label j . Continue this process until all the points labeled j are in the same cluster. The resulting labeling function is t -optimal, contradicting the maximality of j .

□

3.6 *Semiorders*

There are several equivalent definitions of a semiorder. One involves forbidden posets: P is a semiorder if and only if it does not contain a $\mathbf{2} + \mathbf{2}$ or a $\mathbf{3} + \mathbf{1}$ as a subposet. Alternatively, semiorders are also known as unit interval orders: $P = (V, \prec)$ is a semiorder if we can assign a unit interval $I(v)$ in the real line to each $v \in V$ so that $x \prec y$ in P precisely when $I(x)$ is completely to the left of $I(y)$. Such unit interval representations can always be found so that the interval endpoints are distinct (see, for example, [9]). In what follows, we will always choose interval representations with distinct endpoints.

Since Theorem 31 shows that computing $d_t(P)$ is NP-complete in general, we seek special classes of posets for which $d_t(P)$ can be computed in polynomial time. A natural class to consider are the semiorders since both the linear discrepancy and the

weak discrepancy can be computed efficiently for semiorders (see Tanenbaum, Trenk and Fishburn [23]).

Theorem 32. ([23]) *Let P be a semiorder, Then*

- (a) $ld(P) = width(P) - 1$ and
- (b) $wd(P) \leq 1$.

In particular, $wd(P) = 1$ if P contains a $\mathbf{2} + \mathbf{1}$ and $wd(P) = 0$ otherwise.

The following result gives bounds on the t -discrepancy of a semiorder $P = (V, \prec)$. The upper and lower bounds differ by less than two, so Theorem 33 restricts the value of $d_t(P)$ to at most two integers. Note that if $t = 1$, then $d_t(P) = ld(P)$ and indeed Theorem 33 reduces to Theorem 32(a). Similarly, if $t \geq |V|$, then $d_t(P) = wd(P)$ and in this case Theorem 33 reduces to Theorem 32(b).

Theorem 33. *If $P = (V, \prec)$ is a semiorder and t is a positive integer, then*

$$\left\lceil \frac{width(P)}{t} - 1 \right\rceil \leq d_t(P) \leq \left\lfloor \frac{width(P)}{t} + 1 - \frac{2}{t} \right\rfloor.$$

Proof. First we establish the lower bound. Let A be an antichain in P of size $width(P)$, thus $|A| = width(P)$. Using Remark 23 and Lemma 24 we have $d_t(P) \geq d_t(A) = \left\lceil \frac{|A|}{t} \right\rceil - 1 = \left\lceil \frac{|width(P)|}{t} \right\rceil - 1 = \left\lceil \frac{|width(P)|}{t} - 1 \right\rceil$.

Next we establish the upper bound. If P is a chain then $width(P) = 1$ and $d_t(P) = 0$ so the result holds. Otherwise, P has at least one pair of incomparable elements. We label the elements of V according to the following greedy algorithm.

Greedy Algorithm for Labeling Semiorders:

Fix a unit interval representation of P in which endpoints are distinct. Consider the elements of $V = \{x_1, x_2, \dots, x_n\}$ indexed by their left endpoint (and therefore also by their right endpoint) in this representation. Initialize: Let $f(x_1) = 0$.

Iterate for $i = 1, 2, \dots, n - 1$: Assume that x_1, x_2, \dots, x_i have been labeled and let $j = f(x_i)$. If there are fewer than t elements labeled j and x_{i+1} is incomparable to all of them, then let $f(x_{i+1}) = j$. Otherwise, let $f(x_{i+1}) = j + 1$.

Example 34 shows the greedy algorithm applied to the representation of the semiorder given in Figure 28.

Note that by construction, the function f satisfies (i) and (iii) of Definition 5. Let k be the largest value for which there exists $x, y \in V$ with $x \parallel y$ and $|f(x) - f(y)| = k$. Then by construction, the function f is a (k, t) -labeling of P and hence $d_t(P) \leq k$. Choose integers r, s with $1 \leq r < s \leq n$ so that $x_r \parallel x_s$ and $f(x_s) - f(x_r) = k$. Thus the intervals assigned to x_r and x_s intersect in an interval we call \mathcal{I} . Since our representation of P is a unit interval representation with points indexed by left endpoints, the intervals assigned to x_r, x_{r+1}, \dots, x_s all intersect the interval \mathcal{I} and thus the points x_r, x_{r+1}, \dots, x_s form an antichain A .

By the definition of f , we know there are t points in A that received the label $f(x_r) + i$ for $i = 1, 2, \dots, k - 1$ and two additional points, x_r and x_s in A . Thus $\text{width}(P) \geq |A| \geq t(k - 1) + 2 \geq t(d_t(P) - 1) + 2$. Isolating the term $d_t(P)$ yields the inequality $d_t(P) \leq \frac{\text{width}(P)}{t} + 1 - \frac{2}{t}$, and because $d_t(P)$ is an integer, we may take the floor of the right hand side to achieve the desired inequality. \square

Example 34. Let $t = 2$ and consider the semiorder P and its representation from Figure 28. The semiorder P has $\text{width}(P) = 6$ and Theorem 33 gives the inequalities $2 \leq d_2(P) \leq 3$. The greedy algorithm assigns the labeling $f(x_1) = 0, f(x_2) = 0, f(x_3) = 1, f(x_4) = 1, f(x_5) = 2, f(x_6) = 2, f(x_7) = 3$. This is a $(3, 2)$ -labeling of P , so $d_2(P) \leq 3$. The value $k = 3$ is attained uniquely at $x = x_r = x_2, y = x_s = x_7$ and the antichain formed is $A = \{x_2, x_3, x_4, x_5, x_6, x_7\}$ with $|A| = 6$. We will see in Section 3.6 that $d_2(P) = 2$.

We next develop a polynomial-time algorithm for finding the t -discrepancy of a semiorder. Given any poset $P = (V, \prec)$, a linear extension $L = (x_1 \prec x_2 \prec \dots \prec x_n)$ of P and an integer-valued function f defined on V , we get a sequence of integers $s(L, f) : f(x_1), f(x_2), \dots, f(x_n)$. If the sequence $s(L, f)$ is non-decreasing, we say f is *nondecreasing on L* . If not, we say $s(L, f)$ *first fails at position r* if there exists

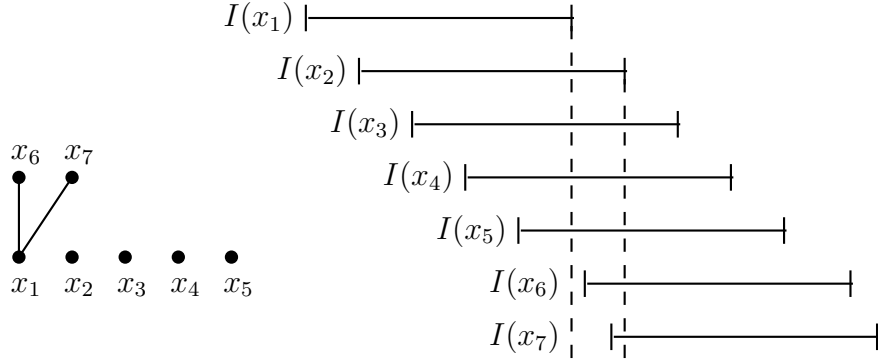

Figure 28: A semiorder P and a representation of it as a unit interval order.

$s > r$ so that $f(x_r) > f(x_s)$ but whenever $i < r$, we have $i < j$ implies $f(x_i) \leq f(x_j)$. For example, the sequence 1, 1, 2, 3, 3, 4, 5, 2 first fails at position 4 with $f(x_4) = 3 > 2 = f(x_8)$.

In Example 34 with $L = (x_1 \prec x_2 \prec \cdots \prec x_7)$, the sequence $s(L, f)$ is 0, 0, 1, 1, 2, 2, 3 which is non-decreasing. More generally, any sequence $s(L, f)$ arising from the greedy algorithm for labeling semiorders will be non-decreasing by construction. However, as we saw in Example 34, a labeling arising from the greedy algorithm is not always optimal. The next lemma shows that for any semiorder P and the linear extension L given by the left endpoint ordering of any unit interval representation of P , there exists an optimal labeling function f for which $s(L, f)$ is non-decreasing. This lemma is crucial in proving the correctness of our algorithm for computing the t -discrepancy of a semiorder.

Lemma 35. *Let $P = (V, \prec)$ be a semiorder and fix a unit interval representation of P with distinct endpoints. Let L be the linear extension of P given by the left endpoint ordering of this representation. Then there exists a labeling f of P that is t -optimal and is non-decreasing on L .*

Proof. Let $n = |V|$ and $I(v)$ be the unit interval assigned to v in the representation. Let L be the linear extension $x_1 \prec_L x_2 \prec_L \cdots \prec_L x_n$ of P given by the left endpoint

ordering in this representation. We wish to show a t -optimal labeling function f of P exists that is non-decreasing on L . For a contradiction, assume no such t -optimal labeling exists and let f be a t -optimal labeling that first fails at position r where r is maximum. By assumption, $r \leq n - 1$. To reach a contradiction, we will construct a labeling function g of P that is t -optimal and first fails at position $\ell > r$.

Let $f(x_r) = b$, let $a = \min\{f(x_i) : i \geq r + 1\}$, and let x_s be any point with $f(x_s) = a$ and $s \geq r + 1$. Since $s(L, f)$ first fails at position r , we know $f(x_s) = a < b = f(x_r)$. Create a new labeling function g by swapping the labels of x_r and x_s , that is, $g(x_i) = f(x_i)$ for $i \notin \{r, s\}$ and $g(x_r) = a$ and $g(x_s) = b$. We next show that g is a t -optimal labeling function of P .

First note that g satisfies condition (iii) of Definition 5 because f is a (k, t) -labeling for P and g simply swaps two of these labels. Similarly, for any points $x_i, x_j \notin \{x_r, x_s\}$, we know that (i) and (ii) are satisfied for g because they are satisfied for f . Thus we need only show that conditions (i) and (ii) are satisfied when one or both of x_i, x_j are in the set $\{x_r, x_s\}$.

Since $f(x_r) > f(x_s)$, by condition (i) of Definition 5 we know that $x_r \not\prec x_s$. In addition, $x_s \not\prec x_r$ because $x_r \prec_L x_s$ and L is a linear extension of P . Thus

$$x_r \parallel x_s \text{ and } |g(x_r) - g(x_s)| = |f(x_s) - f(x_r)| \leq k. \quad (4)$$

It remains to consider a point $x_i \in V - \{x_r, x_s\}$ and to check that the pairs x_i, x_r and x_i, x_s satisfy (i) and (ii) of Definition 5 for the function g .

First consider x_i with $x_i \prec x_r$. By the definition of L , the left endpoint of $I(x_r)$ comes before the left endpoint of $I(x_s)$, so $x_i \prec x_r$ implies $x_i \prec x_s$. Since f is a (k, t) -labeling for P , we know $g(x_i) = f(x_i) < f(x_s) = g(x_r)$ and $g(x_i) = f(x_i) < f(x_r) = g(x_s)$ as desired.

Next consider x_i with $x_r \prec x_i$. In this case, $b = f(x_r) < f(x_i) = g(x_i)$ and thus $g(x_r) = a < b < g(x_i)$ so the pair x_i, x_r satisfies condition (i) of Definition 5 for g . We next consider the pair x_s, x_i . If $x_s \prec x_i$ then $g(x_s) = b < g(x_i)$ as desired. If

$x_i \prec x_s$ then transitivity yields $x_r \prec x_s$, contradicting $x_r \parallel x_s$ from (4). Otherwise, $x_s \parallel x_i$ and since f satisfies (ii) of Definition 5 we have $|f(x_i) - a| \leq k$. Now $|g(x_i) - g(x_s)| = |f(x_i) - b| \leq |f(x_i) - a| \leq k$ where the inequality follows because $a < b < f(x_i)$.

Finally, consider x_i with $x_r \parallel x_i$. If $x_s \prec x_i$ we show a contradiction arises. Given that $r < s$ and our representation is unit, we know the right endpoint of $I(x_r)$ is smaller than the right endpoint of $I(x_s)$. Then $x_s \prec x_i$ would imply $x_r \prec x_i$, a contradiction. If $x_s \parallel x_i$ then $|g(x_r) - g(x_i)| = |f(x_s) - f(x_i)| \leq k$ and $|g(x_s) - g(x_i)| = |f(x_r) - f(x_i)| \leq k$ because f is a (k, t) -labeling of P . Lastly consider $x_i \prec x_s$. In this instance, $f(x_i) < f(x_s) = a < b$ so $g(x_i) = f(x_i) < b = g(x_s)$ and g satisfies (i) for the pair x_i, x_s . For the pair x_i, x_r we show $|g(x_i) - g(x_r)| \leq k$. Since this is a unit representation and $x_i \prec x_s, x_i \parallel x_r$ and $x_r \parallel x_s$, we know the left endpoint of $I(x_i)$ comes before the left endpoint of $I(x_r)$, thus $i < r$. By our assumption that f first fails at position r , $f(x_i) \leq f(x_s) = a$. Now $|g(x_i) - g(x_r)| = |f(x_i) - a| < |f(x_i) - b| = |f(x_i) - f(x_r)| \leq k$ with the inequality following from $f(x_i) \leq a < b$. \square

We next present an algorithm that determines whether a semiorder has a (k, t) -labeling and in the affirmative case, constructs such a labeling. This algorithm is a modification of the algorithm for determining whether a poset has weak discrepancy at most k in [24]. As we will see in Corollary 40, this can be used to calculate $d_t(P)$. We discuss correctness and complexity afterwards.

Algorithm (k, t) -Labeling for Semiorders

Input: An ordered set $P = (V, \prec)$, integers $k \geq 0$ and $t \geq 1$.

Output: A (k, t) -labeling function $f : V \rightarrow \mathbf{Z}$ of P , or the statement that no such labeling exists.

The algorithm:

Step 1: Construct a unit interval representation of P with distinct endpoints in which $x_i \in V$ is assigned the unit interval $I(x_i)$. This can be accomplished in linear time (see [7]).

Consider the elements of $V = \{x_1, x_2, \dots, x_n\}$ indexed by their left endpoint in the representation.

Step 2: [Initialization Step] Let $f(x_1) = 0$ and let $U = \{2, 3, \dots, n\}$.

Form a $\{0, 1\}$ -matrix M whose rows and columns are indexed by U . Initialize:

$$M_{ij} = \begin{cases} 1 & \text{if } i = j, \\ 0 & \text{otherwise.} \end{cases}$$

Step 3: [Assign Initial Ranges] Assign the range for x_1 as $R(x_1) = [\ell(x_1), u(x_1)] = [0, 0]$ and the range $R(x_i) = [\ell(x_i), u(x_i)]$ for each $i \in U$ as follows:

- If $x_1 \prec x_i$ set $R(x_i) = [1, n - 1]$.
- If $x_1 \parallel x_i$ set $R(x_i) = [0, k]$.

Since we indexed the elements of V by left endpoints in the unit interval representation of P , we can not have $x_i \prec x_1$.

Step 4: [Narrowing the Ranges]

Narrowing Steps (NS): Pick two distinct indices $2 \leq i < j \leq n$ with $M_{ij} = 0$.

Thus either $x_i \prec x_j$ or $x_i \parallel x_j$.

- (a) If $x_i \prec x_j$ and $\ell(x_j) \leq \ell(x_i)$, increase $\ell(x_j)$ to $\ell(x_i) + 1$.
- (b) If $x_i \prec x_j$ and $u(x_i) \geq u(x_j)$, decrease $u(x_i)$ to $u(x_j) - 1$.
- (c) If $x_i \parallel x_j$ and $u(x_j) \geq u(x_i) + k + 1$, decrease $u(x_j)$ to $u(x_i) + k$.
- (d) If $x_i \parallel x_j$ and $u(x_i) \geq u(x_j) + k + 1$, decrease $u(x_i)$ to $u(x_j) + k$.
- (e) If $x_i \parallel x_j$ and $\ell(x_j) \leq \ell(x_i) - k - 1$, increase $\ell(x_j)$ to $\ell(x_i) - k$.

(f) If $x_i \parallel x_j$ and $\ell(x_i) \leq \ell(x_j) - k - 1$, increase $\ell(x_i)$ to $\ell(x_j) - k$.

If $\ell(x_i) > u(x_i)$ or $\ell(x_j) > u(x_j)$, STOP. There is no (k, t) -labeling of P .

If $R(x_i)$ was narrowed in this pass of the narrowing steps, set $M_{ir} = M_{ri} = 0$ for all r other than i and j . Likewise, if $R(x_j)$ was narrowed in this pass of the narrowing steps, set $M_{jr} = M_{rj} = 0$ for all r other than i and j .

In any event, set $M_{ij} = M_{ji} = 1$.

If all entries of M are 1's, continue to Step 5. Otherwise, begin Step 4 again.

Step 5: [Sweeping steps]

(a) Left to right sweep: For $i = 1$ to $n - t$,

- if $\ell(x_{i+t}) \leq \ell(x_i)$, increase $\ell(x_{i+t})$ to $\ell(x_i) + 1$.
- If $\ell(x_{i+t}) > u(x_{i+t})$, STOP. There is no (k, t) -labeling of P .

(b) Right to left sweep: For $i = n$ down to $t + 1$,

- if $u(x_{i-t}) \geq u(x_i)$, decrease $u(x_{i-t})$ to $u(x_i) - 1$.
- If $u(x_{i-t}) < \ell(x_{i-t})$, STOP. There is no (k, t) -labeling of P .

If no values were changed in Step 5, then continue to Step 6. Otherwise, begin Step 4 again.

Step 6: Set $f(x_i) = \ell(x_i)$ for $i = 2, 3, 4, \dots, n - 1$.

(End of Algorithm (k, t) -Labeling for Semiorders)

Illustration of Algorithm (k, t) -Labeling for Semiorders

In Table 1 we illustrate how the ranges change when Algorithm (k, t) -Labeling for semiorders is applied to the semiorder P shown in Figure 28 in the instance of $t = 2$ and $k = 2$. In this example, at the end, each range set consists of a single integer, and we obtain the $(2, 2)$ -labeling function $f(x_1) = 0, f(x_2) = 1, f(x_3) = 1, f(x_4) = 2$,

	i	1	2	3	4	5	6	7
Step 3		[0,0]	[0,2]	[0,2]	[0,2]	[0,2]	[1,6]	[1,6]
Step 4(c)	$x_2 \parallel x_6$	[0,0]	[0,2]	[0,2]	[0,2]	[0,2]	[1,4]	[1,6]
Step 4(c)	$x_2 \parallel x_7$	[0,0]	[0,2]	[0,2]	[0,2]	[0,2]	[1,4]	[1,4]
Step 5a		[0,0]	[0,2]	[1,2]	[1,2]	[2,2]	[2,4]	[3,4]
Step 5b		[0,0]	[0,1]	[1,1]	[1,2]	[2,2]	[2,4]	[3,4]
Step 4(c)	$x_2 \parallel x_6$	[0,0]	[0,1]	[1,1]	[1,2]	[2,2]	[2,3]	[3,4]
Step 4(c)	$x_2 \parallel x_7$	[0,0]	[0,1]	[1,1]	[1,2]	[2,2]	[2,3]	[3,3]
Step 4(f)	$x_2 \parallel x_7$	[0,0]	[1,1]	[1,1]	[1,2]	[2,2]	[2,3]	[3,3]
Step 5(a)		[0,0]	[1,1]	[1,1]	[2,2]	[2,2]	[3,3]	[3,3]

Table 1: The ranges $R(x_i)$ when $k = 2$, $t = 2$, $n = 7$, and the algorithm applied to the semiorder P shown in Figure 28.

$f(x_5) = 2$, $f(x_6) = 3$, $f(x_7) = 3$. Thus $d_t(P) \leq 2$. We observe that this function is an improvement over the one constructed using the greedy algorithm in Example 34.

Next we consider this same semiorder P , the same unit interval representation, and continue to consider $t = 2$ but change the value of k .

When $k = 1$ the initial range values assigned in Step 3 are $[0, 0]$ for x_1 , $[0, 1]$ for x_2, x_3, x_4, x_5 and $[1, 6]$ for x_6, x_7 . In Step 4, comparing x_2 with x_6 and x_7 results in narrowing $R(x_6)$ and $R(x_7)$ to $[1, 2]$ and these are the only changes that occur. In the left to right sweep of Step 5, we get $\ell(x_5) = 2$ and $u(x_5) = 1$, and the algorithm stops with the conclusion that $d_2(P) > 1$. Combining this with $d_t(P) \leq 2$ from above, we conclude $d_t(P) = 2$.

When $k = 3$ the initial range values assigned in Step 3 are $[0, 0]$ for x_1 , $[0, 3]$ for x_2, x_3, x_4, x_5 and $[1, 6]$ for x_6, x_7 . No changes occur as a result of applying Step 4. After both sweeping passes are made in Step 5, the ranges are $R(x_1) = [0, 0]$, $R(x_2) = [0, 2]$, $R(x_3) = [1, 2]$, $R(x_4) = [1, 3]$, $R(x_5) = [2, 3]$, $R(x_6) = [2, 6]$, $R(x_7) = [3, 6]$. No further modifications occur in the range sets, and thus the resulting labeling is indeed a $(3, 2)$ -labeling of P , but is not 2-optimal. Indeed, it is the same labeling found by the greedy algorithm in Example 34.

Correctness and Complexity of Algorithm (k, t) -Labeling for Semiorders

We establish the correctness of Algorithm (k, t) -labeling for semiorders using Lemma 35 and two propositions. After this we consider the complexity of the algorithm.

Proposition 36. *If Algorithm (k, t) -labeling for semiorders terminates with all ranges non-empty, then $d_t(P) \leq k$ and picking the smallest element in each range set is a valid (k, t) -labeling.*

Proof. Suppose that $R(v) = [\ell(v), u(v)]$ is the range assigned to point v when the algorithm terminates. Let $f(v) = \ell(v)$ for each $v \in V$. It suffices to show that f is a valid (k, t) -labeling for P . We consider any pair of distinct points x_i, x_j in P and show that conditions (i), (ii) and (iii) of Definition 5 are satisfied. Without loss of generality, we may assume $i < j$ and thus either $x_i \prec x_j$ or $x_i \parallel x_j$. If $x_i \prec x_j$ then by Step 4(a) of the algorithm, $\ell(x_j) \geq \ell(x_i) + 1$ thus $f(x_i) < f(x_j)$ as required by (i). If $x_i \parallel x_j$ then by Steps 4(e) and 4(f) of the algorithm, $\ell(x_i) - k \leq \ell(x_j) \leq \ell(x_i) + k$ thus $|f(x_i) - f(x_j)| \leq k$ as required by (ii). As a result of the left to right sweep in Step 5, if $\ell(x_i) = r$ then $\ell(x_{i+t}) \geq r + 1$, thus at most t points can receive the label $f(x) = \ell(x) = r$ for each r , establishing (iii). \square

Proposition 37. *If P is a semiorder with $d_t(P) \leq k$ then Algorithm (k, t) -labeling for semiorders terminates with each range set non-empty.*

Proof. In Step 1 of the algorithm, a unit interval representation of P is constructed in which all endpoints of intervals are distinct. As in the algorithm, we consider the points of $V = \{x_1, x_2, \dots, x_n\}$ indexed by their left endpoint in this representation. Let L be the linear extension $x_1 \prec_L x_2 \prec_L \dots \prec_L x_n$ of P . By Lemma 35, there exists a labeling function f that is t -optimal and non-decreasing on L . Thus f is a (k, t) -labeling of P and $f(x_i) \leq f(x_j)$ whenever $i < j$.

As in the proof of Lemma 21(a), we may add a constant to each function value so that $f(x_1) = 0$ and the resulting function is still non-decreasing on L . Similarly, following the proof of Lemma 21, we may assume that $f(x_i) \leq n - 1$ for each i . Therefore, the initial ranges assigned in Step 3 of the algorithm satisfy $f(x_i) \in R(x_i)$ for $i = 2, 3, 4, \dots, n$.

Indeed, we will see that as we continue through the algorithm, we maintain the invariant:

$$(*) f(x_i) \in R(x_i), \text{ or equivalently, } \ell(x_i) \leq f(x_i) \leq u(x_i) \text{ for } i = 2, 3, \dots, n.$$

In Step 4 of the algorithm, we apply (i) of Definition 5 (in Steps 4(a) and 4(b)) or (ii) of Definition 5 (in Steps 4(c) – 4(f)) to the pair (x_i, x_j) . For example, if $(*)$ holds true at the start of Step 4(a), and if $x_i \prec x_j$ then $f(x_i) < f(x_j)$ hence $\ell(x_i) \leq f(x_i) < f(x_j)$. Since f is an integer-valued function we know $f(x_j) \geq \ell(x_i) + 1$ and we can narrow the range of possible values for $f(x_j)$ to $[\ell(x_i) + 1, u(x_j)]$. Thus $(*)$ holds true at the end of Step 4(a). Similarly, we maintain the invariant $(*)$ when the other parts of Step 4 are applied.

The sweeping steps (step 5) of the algorithm proceed by applying Lemma 35 and (iii) of Definition 5. Since f is non-decreasing on L and there are at most t occurrences of the function value $f(x_i)$, we know $f(x_{i+t}) > f(x_i) \geq \ell(x_i)$ so we can increase $\ell(x_{i+t})$ to $\ell(x_i) + 1$.

Thus the algorithm maintains the invariant $(*)$. Since the function f exists, each range $R(x_i)$ must contain the value $f(x_i)$ and thus be non-empty when the algorithm terminates. □

Theorem 38. *Algorithm (k, t) -labeling for semiorders correctly determines whether a semiorder P has $d_t(P) \leq k$ and in the affirmative case, it produces a (k, t) -labeling for P .*

Proof. There are two ways in which the algorithm can terminate: either in Step 4

when a range is narrowed to the empty set, or in Step 6 when all ranges stabilize, are non-empty and can not be narrowed further. In the former case, we conclude $d_t(P) > k$ by the contrapositive of Proposition 37. In the latter case, Proposition 36 implies that $d_t(P) \leq k$ and picking the smallest element in each range set is a valid (k, t) -labeling for P . \square

Theorem 39. *With input $P = (V, \prec)$, and $n = |V|$, Algorithm (k, t) -labeling for semiorders runs in time $O(n^4)$.*

Proof. Step 1 can be accomplished in time $O(n)$ as shown by Gardi in [7]. Clearly Step 2 runs in time $O(n^2)$ and Steps 5 and 6 in time $O(n)$, so we focus on Step 4.

The initial ranges have length at most $n - 2$, where the length of range $R(x_i)$ is defined as $u(x_i) - \ell(x_i)$. When a range is narrowed, its length decreases by at least 1, hence each range is narrowed at most $n - 1$ times. Thus at most n^2 narrowings occur during Step 4 over the course of the whole algorithm.

Furthermore, after all $\binom{n-1}{2} < n^2$ pairs of points are considered, either a narrowing occurs or the matrix M fills with 1's and the algorithm proceeds to Step 5. Thus the total amount of time spent in Step 4 is $O(n^4)$. \square

Finally, Algorithm (k, t) -labeling for semiorders can be applied repeatedly with different values of k to determine $d_t(P)$.

Corollary 40. *Given $P = (V, \prec)$ with $n = |V|$, we can determine $d_t(P)$ in time $O(n^4 \log n)$.*

Proof. Use Algorithm (k, t) -labeling for semiorders to determine if $d_t(P) \leq k$ for $k = 0, 1, 2, \dots$ and stop as soon as a value of k is found for which an affirmative answer is reached. That value of k is $d_t(P)$. By Remark 22 we know $d_t(P) \leq n - 1$, so we would need to run the algorithm a maximum of $n - 1$ times giving a total running time of $O(n^5)$. The running time can be shortened to $O(n^4 \log n)$ if we instead use a binary search to choose the appropriate values of k . \square

3.7 Conclusion and Future Work

Determining a poset's t -discrepancy for fixed t , as explained in a previous section, is particularly difficult. One can argue that it is even more difficult to determine than linear discrepancy as no such polynomial time algorithm exists for even approximating its value. It is known that for any linear extension, the distance between any two incomparable elements in the extension is at most three times the linear discrepancy [19]. Thus, this provides a factor three approximation. In regards to t -discrepancy, no such factor exists because a gap-free labeling will not necessarily be within any fixed constant factor.

As another interesting question to explore with regards to t -discrepancy property is it's complexity when restricted to the class of interval orders. The reduction used in Theorem 31 fails to work for interval orders as determining the linear discrepancy for an interval order can be found in polynomial time using the Kleitman-Vohra algorithm. This algorithm can be found in [18]. My colleagues and I tried to alter this algorithm to give a polynomial algorithm for determining the t -discrepancy for an interval order; however, we were unsuccessful and thus, this problem is still open.

CHAPTER IV

TOTAL LINEAR DISCREPANCY

4.1 Introduction

This chapter discusses the results of paper [13]. Also, these results were independently proven by Brightwell and Patel in [1]. In particular, the results look at the notion of total linear discrepancy of a poset. The definition of total linear discrepancy is given in Chapter 1 Definition 8. The central idea of total linear discrepancy takes a more utilitarian view of “fairness” in a poset. Instead of minimizing the maximum distance between any two incomparable elements, total linear discrepancy is a measure of minimizing average distance between incomparable elements. In general, the linear extensions that witness total linear discrepancy and linear discrepancy can be very different as the following example illustrates.

Let \mathbf{P} be the poset $\mathbf{r} + \mathbf{r}$ where the elements of the first chain are denoted a_1, a_2, \dots, a_r and the second chain denoted b_1, b_2, \dots, b_r . In [23], $ld(\mathbf{P})$ is shown to be $r + \lceil \frac{r}{2} \rceil$ and a linear extension that witnesses it is $a_1, a_2, \dots, a_{\lceil \frac{r}{2} \rceil}, b_1, b_2, \dots, b_r, a_{\lceil \frac{r}{2} \rceil + 1}, a_{\lceil \frac{r}{2} \rceil + 2}, \dots, a_r$. Denote this extension as \mathcal{L}_1 . In [22] the linear extension, \mathcal{L}_2 , that witnesses the total linear discrepancy of \mathbf{P} is given by $a_1, b_1, a_2, b_2, \dots, a_r, b_r$. Note that the $ld_{\mathcal{L}_2}(\mathbf{P}) = 2r - 1$ and is worst possible in terms of linear discrepancy. A simple calculation shows that the average distance between incomparable elements in \mathcal{L}_1 is about $\frac{3}{4}r$ whereas the average distance between incomparable elements in \mathcal{L}_2 is about $\frac{2}{3}r$.

The main result of this chapter shows that the total linear discrepancy can be computed in polynomial time and is witnessed by ordering elements by an easily computed property which we call net height that will be defined in the next section.

We also give a closed formula for the exact value of the total linear discrepancy for a few special classes of posets. In particular, we give formulas for the total linear discrepancy of an antichain and the class of standard examples.

4.2 Total Linear Discrepancy

Intuitively, when trying to find an optimal linear extension that minimizes total linear discrepancy a point with large downset should appear higher in an optimal linear extension and one with large upset should appear lower. This motivates the following definitions which play a key role in characterizing optimal linear extensions.

Definition 41. Let $P = (X, \prec)$ be a poset. The *net height* of $x \in X$, written $\hat{h}(x)$, is $|D(x)| - |U(x)|$.

Definition 42. A linear extension L of poset P is *height ordered* if $L(x) < L(y)$ whenever $\hat{h}(x) < \hat{h}(y)$.

Figure 29 shows the net height $\hat{h}(x)$ listed next to each point x of the poset F . Observe that two points with equal net heights are incomparable and that comparable pairs of points have net heights that differ by at least two. We record this in the following remark.

Remark 43. If $x \prec y$ in P then $\hat{h}(x) + 2 \leq \hat{h}(y)$.

Proof. Given that $x \prec y$, transitivity implies that $D(x) \subset D(y)$ and $U(y) \subset U(x)$. Indeed, $|D(x)| + 1 \leq |D(y)|$ and $|U(y)| + 1 \leq |U(x)|$ because $x \in D(x) \setminus D(y)$ and $y \in U(x) \setminus U(y)$. The result follows from the definition of net height. \square

The next lemma calculates the effect on total linear discrepancy of swapping two consecutive points in a linear extension. We have seen an example of this lemma in the linear extensions L and L' of the fish poset F . In that instance (with $x = b$ and $y = c$) we have $t_{L'}(F) = 9 = 6 + 0 - (-3) = t_L(F) + \hat{h}(c) - \hat{h}(b)$.

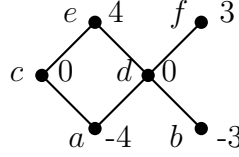

Figure 29: Poset F labeled with net heights.

Lemma 44. *Let L be a linear extension of poset P and let x, y be incomparable elements in P with $L(y) = L(x) + 1$. If L' is the linear extension of P formed by swapping x and y , then*

$$t_{L'}(P) = t_L(P) + \hat{h}(y) - \hat{h}(x).$$

Proof. Define Δ to be $t_{L'}(P) - t_L(P)$. For incomparable pairs u, v with $u, v \notin \{x, y\}$, the terms $|L(u) - L(v)|$ and $|L'(u) - L'(v)|$ are identical. Similarly, they are identical for the incomparable pair x, y . Thus in computing Δ we need only consider the contribution arising from incomparable pairs in which one point is in the set $\{x, y\}$ and the other point t is not. Furthermore, if t is incomparable to both x and y then the sum $|L(t) - L(x)| + |L(t) - L(y)|$ is equal to the sum $|L'(t) - L'(y)| + |L'(t) - L'(x)|$. Thus we need only consider the pairs in which t is incomparable to one of x, y and comparable to the other. There are four such cases to consider in computing Δ .

- (i) $w : L(w) < L(x)$, $w \parallel x$, and $w \prec y$.
- (ii) $z : L(z) > L(y)$, $x \prec z$, and $z \parallel y$.
- (iii) $w' : L(w') < L(x)$, $w' \prec x$, and $w' \parallel y$.
- (iv) $z' : L(z') > L(y)$, $z' \parallel x$, and $y \prec z'$

Each point w in (i) and z in (ii) contributes $+1$ to Δ , and each point w' in (iii) and z' in (iv) contributes -1 to Δ . The number of points w in (i) is $|D(y)| - |D(x) \cap D(y)|$ since each w with $L(w) < L(x)$ will have either $w \prec x$ or $w \parallel x$. Similarly, the

number of points z in (ii) is $|U(x)| - |U(x) \cap U(y)|$, the number of points w' in (iii) is $|D(x)| - |D(x) \cap D(y)|$ and the number of points z' in (iv) is $|U(y)| - |U(x) \cap U(y)|$. Thus $\Delta = |D(y)| + |U(x)| - |D(x)| - |U(y)| = \hat{h}(y) - \hat{h}(x)$ as desired. \square

We are now ready to characterize the linear extensions of P that are optimal with respect to total linear discrepancy.

Theorem 45. *A linear extension L is optimal with respect to total linear discrepancy if and only if L is height ordered.*

Proof. First we prove the forward direction. Assume, for a contradiction, that L is an optimal linear extension of P but that it is not height ordered. Let x, y be a pair of points so that $L(x) < L(y)$ and $\hat{h}(x) > \hat{h}(y)$ and for which $L(y) - L(x)$ is as small as possible. Suppose there exists a point z with $L(x) < L(z) < L(y)$. If $\hat{h}(x) > \hat{h}(z)$, then the pair x, z violates the minimality of $L(y) - L(x)$, and otherwise, $\hat{h}(z) \geq \hat{h}(x) > \hat{h}(y)$, in which case the pair z, y violates this minimality condition. Thus no such z exists and in fact $L(y) - L(x) = 1$.

Because $\hat{h}(x) > \hat{h}(y)$, Remark 43 implies that $x \not\prec y$. Furthermore, since L is a linear extension of P and $L(x) < L(y)$, we know $y \not\prec x$. Thus $x \parallel y$. Swap x and y to obtain another linear extension L' of P . By Lemma 44 we have, $t_P(L') = t_P(L) + \hat{h}(y) - \hat{h}(x) < t_P(L)$. This contradicts the optimality of L .

Next we prove the converse. Let \hat{L} be a linear extension of P that is height ordered and let L be a linear extension of P that is optimal with respect to total linear discrepancy. By the first half of this proof, L is also height ordered. Therefore, \hat{L} and L differ only in the order of points with the same net height and we can transform \hat{L} to L by a sequence of swaps of consecutive points with equal net height. By the contrapositive of Remark 43, each such swap involves an *incomparable pair* x, y with $\hat{h}(x) = \hat{h}(y)$. By Lemma 44, each swap leaves the total linear discrepancy unchanged thus $t_{\hat{L}}(P) = t_L(P)$ and \hat{L} is also an optimal linear extension. \square

Example 46. It follows from Theorem 45 that the poset F in Figure 29 has exactly two optimal linear extensions, where points c and d may appear in either order: $a \prec b \prec \{c, d\} \prec f \prec e$.

In general, Theorem 45 allows us to find an optimal linear extension efficiently and from there to calculate the total linear discrepancy. It also allows us to calculate the number of optimal linear extensions. We record these as corollaries.

Corollary 47. *Let P be a poset and a_1, a_2, \dots, a_r be the set of distinct net heights that occur among points of P . If b_i is the number of points of P that have net height equal to a_i , then the number of linear extensions of P that are optimal is $b_1! b_2! \cdots b_r!$.*

Corollary 48. *A linear extension of a poset P that is optimal with respect to total linear discrepancy can be constructed in polynomial time.*

4.3 Special Classes of Posets

In this section, we consider applying our results to several special classes of posets – antichains, the standard examples S_n of posets of dimension n , and the sum of chains.

While Theorem 45 allows us to determine precisely which linear extensions of a poset are optimal, it does not provide a closed form expression for the value of the total linear discrepancy. We do have formulas for the total linear discrepancy in two special cases.

Lemma 49. *If A_n is an antichain on n points then $\text{tl}(A_n) = \binom{n+1}{3}$.*

Proof. We proceed by induction. For A_2 the result is clearly true. We assume $\text{tl}(A_{k-1}) = \binom{k}{3}$ and show $\text{tl}(A_k) = \binom{k+1}{3}$. Any linear extension $L : x_1 \prec x_2 \prec \cdots \prec x_k$ of A_k will be optimal, so we need only calculate $t_L(A_k) = \sum_{1 \leq i < j \leq k} |L(x_i) - L(x_j)|$. Separating out the terms involving x_k yields

$$t_L(A_k) = (1 + 2 + 3 + \cdots + k - 1) + \text{tl}(A_{k-1}) = \binom{k}{2} + \binom{k}{3} = \binom{k+1}{3}.$$

□

Proposition 50. *If S_n is the standard example poset on n points then*

$$\text{tl}(S_n) = 2\binom{n+1}{3} + n^2.$$

Proof. Each minimal element x_i has net height $\hat{h}(x_i) = -(n-1)$ and each maximal element y_i has net height $\hat{h}(y_i) = (n-1)$. By Theorem 45, any linear extension in which all the x 's appear below all of the y 's is optimal, so we will use the linear extension $L : x_1 \prec x_2 \cdots \prec x_n \prec y_1 \prec y_2 \cdots \prec y_n$. The minimal points form an antichain as do the maximal points. For each incomparable pair of the form $x_i \parallel y_i$, we have $|L(x_i) - L(y_i)| = n$. Thus, using Lemma 49, we have

$$\text{tl}(S_n) = t_L(S_n) = 2 \text{tl}(A_n) + n^2 = 2\binom{n+1}{3} + n^2.$$

□

4.4 Conclusion and Future Work

Determining an ordering that witnesses the linear discrepancy of a poset is very difficult as it is in the class of NP-Complete Problems. Additionally, finding an ordering that witnesses a posets weak discrepancy, though easy to compute, will give a non-injective ordering. The benefits to total discrepancy is that it provides a fair injective ordering and can be computed in polynomial time (in fact the algorithm runs faster than the algorithm that determines an optimal weak discrepancy labeling [8]).

Perhaps the biggest question that comes from these results is whether there is a relationship between total linear discrepancy and any of the other forms of discrepancy. In particular, can ordering by total linear discrepancy give a bound on the linear discrepancy of a poset. Currently, the best known approximation bound for linear discrepancy guarantees only three times that of the optimal value [20]. This is a basic bound because any linear extension witnesses this factor. This is the best known bound in general. Can one prove that a linear extension that is height ordered achieves a better approximation?

CHAPTER V

WHEN WEAK DISCREPANCY EQUALS LINEAR DISCREPANCY

5.1 *Introduction*

As mentioned in chapter 2, the notion of linear and weak discrepancy were introduced in [6, 23]. These papers proved different results on these properties; in particular, they gave a polynomial time algorithm for determining weak discrepancy and it gave a reduction that showed determining linear discrepancy was an NP-Complete problem. At the end of [23], a series of eight questions/problems was posed. The first question gave the problem of characterizing posets of linear discrepancy 2. This was answered over two papers [11, 12] and the first half of the proof is presented in chapter 2. The second problem posed was to determine those posets whose linear discrepancy is equal to its weak discrepancy. This chapter focuses on giving an answer to this question.

We first show that in general this problem is NP-Complete and we provide a reduction. This is unsurprising as there exist posets \mathbf{P} with disjoint subposets $\mathbf{P}_1, \mathbf{P}_2$ such that $wd(\mathbf{P}_1) = wd(\mathbf{P})$ and $ld(\mathbf{P}_2) = ld(\mathbf{P})$. Additionally, it is possible to construct examples where $ld(\mathbf{P}_1) = wd(\mathbf{P}_1)$. Thus, the subposet \mathbf{P}_1 determines $wd(\mathbf{P})$; however, $ld(\mathbf{P})$ is determined independently of \mathbf{P}_1 . A simple construction is to take any poset whose linear discrepancy is equal to its weak discrepancy and then attach a large antichain where every point in the antichain is less than any other point not in the antichain.

Though this at first glance closes the door on this idea, it is still possible to characterize the tight examples. In other words, which posets have linear discrepancy equal to weak discrepancy and the removal of any point drops the weak discrepancy? Choi

and West in [4] characterized the minimal posets whose weak discrepancy is k (the removal of any point lowers the posets weak discrepancy value). Among these posets we show specifically those posets that have equivalent linear and weak discrepancy values.

The last result of the section shows that these minimal posets are in fact interval orders and we provide a more natural description of this class of tight examples.

5.2 Preliminaries

At this point it is worth noting that calculating the linear discrepancy of a poset is NP-complete via a reduction to the bandwidth of its co-comparability graph [6, 23] while the weak discrepancy can be calculated in polynomial time [24, 8]. Thus it is natural to hope that the answer to the question of Tanenbaum, et al. is in the form of a polynomial time algorithm, however, the following reduction indicates that this is unlikely to be the case. That is, there is not a polynomial time algorithm unless $P = NP$.

A key component of the reduction is the following lemma from [23].

Lemma 51. *If P can be partitioned into two sets U and V such that for all $u \in U$ and $v \in V$, $u < v$, then $\text{ld}(P) = \max \{\text{ld}(U), \text{ld}(V)\}$ and $\text{wd}(P) = \max \{\text{wd}(U), \text{wd}(V)\}$.*

Theorem 52. *Determining whether $\text{ld}(P) = \text{wd}(P)$ is NP-complete.*

Proof. Since determining the linear discrepancy is in NP and determining the weak discrepancy is polynomial, determining whether they are equal is clearly in NP. Thus it suffices to show that there is an NP-complete problem that can be reduced in polynomial time to determining whether the linear and weak discrepancy are equal. The natural candidate for this is determining the linear discrepancy of a poset P . If $\text{ld}(P) = \text{wd}(P)$ the linear discrepancy may be determined by finding the weak discrepancy of P , therefore we may assume that $\text{wd}(P) < \text{ld}(P)$.

Now for all j , let P_j be the poset consisting of a chain of length $2j$ and a single isolated point and observe that $\text{ld}(P_j) = \text{wd}(P_j) = j$. Let X be the ground set of P and let Y_j be the ground set of P_j . For each j from 1 to $|X|$, define the poset P'_j on the ground set $X \cup Y_j$ by letting P'_j be equal to P on X , equal to P_j on Y_j and letting $y < x$ for every $y \in Y_j$ and $x \in X$. Now by Lemma 51, $\text{ld}(P'_j) = \max\{\text{ld}(P), \text{ld}(P_j)\}$ and $\text{wd}(P'_j) = \max\{\text{wd}(P), \text{wd}(P_j)\}$. Thus for $1 \leq j < \text{ld}(P)$, we have $\text{wd}(P'_j) \neq \text{ld}(P'_j)$ and for $j \geq \text{ld}(P)$, we have $\text{wd}(P'_j) = \text{ld}(P'_j)$. Thus $\text{ld}(P)$ is the first j such that $\text{ld}(P'_j) = \text{wd}(P'_j)$. Hence if calculating whether linear and weak discrepancy are equal were polynomial, then determining the linear discrepancy of P would be as well, and thus determining whether linear and weak discrepancy are equal is NP-complete. \square

Thus, rather than attempting to explicitly characterize all posets for which linear and weak discrepancy are the same, we follow the work in [3, 11, 12] and determine essential characteristics of posets with equal linear and weak discrepancy. To that end, we recall that a poset P is *d-linear-discrepancy-irreducible* if $\text{ld}(P) = d$ and for any $x \in P$ we have $\text{ld}(P - \{x\}) < d$. We define *d-weak-discrepancy-irreducible* analogously. Additionally, we say a poset P is *(s, t)-discrepancy irreducible* (or simply *(s, t)-irreducible*) if $\text{ld}(P) = s$ and $\text{wd}(P) = t$ and for any point $x \in P$ either $\text{ld}(P - \{x\}) < s$ or $\text{wd}(P - \{x\}) < t$. If $s = t$ then we may replace, without loss of generality, the second condition with for any $x \in P$, $\text{wd}(P - \{x\}) < t$. That is, if a poset is (d, d) -irreducible then it is also *d-weak-discrepancy-irreducible*. Further, we note that if a poset P is such that $\text{ld}(P) = s$ and $\text{wd}(P) = t$ then there are induced subposets of P , denoted P_s , P_t and $P_{(s,t)}$, such that P_s is *s-linear-discrepancy-irreducible*, P_t is *t-weak-discrepancy-irreducible*, and $P_{(s,t)}$ is *(s, t)-irreducible*. With these definitions in hand we review some preliminary work on weak discrepancy.

5.3 Weak Discrepancy Preliminaries

In a poset P a *forcing cycle* is a sequence of elements $C = c_1, c_2, \dots, c_k$ such that for all i either $c_i < c_{i+1}$ or $c_i \parallel c_{i+1}$ and (without loss of generality) $c_1 \parallel c_k$. Given a forcing cycle C , define $\text{up}(C)$ as $|\{i \mid c_i < c_{i+1}, 1 \leq i \leq k-1\}|$ and $\text{side}(C)$ as $1 + |\{i \mid c_i \parallel c_{i+1}, 1 \leq i \leq k-1\}|$. That is, $\text{up}(C)$ is the number of up steps along the cycle and $\text{side}(C)$ is the number of incomparable steps when viewing C cyclically since $c_1 \parallel c_k$. Using this notation, Gimbel and Trenk, prove the following theorem [8].

Theorem 53. *Let P be a poset and \mathcal{C} be the set of forcing cycles on P , then $\text{wd}(P) = \max_{C \in \mathcal{C}} \left\lceil \frac{\text{up}(C)}{\text{side}(C)} \right\rceil$. Furthermore, if $C = c_1, c_2, \dots, c_k$ is a maximal forcing cycle and f is a fractional labelling of P where $f(c_1) = 0$ and $f(c_{i+1}) = f(c_i) + 1$ if $c_i < c_{i+1}$ and $f(c_{i+1}) = f(c_i) - \frac{\text{up}(C)}{\text{side}(C)}$ if $c_i \parallel c_{i+1}$. Then $\lceil f \rceil$ is an optimal weak discrepancy labelling.*

In fact, Gimbel and Trenk prove the stronger result that the f provided is in fact optimal over all fractional weak order preserving maps, yielding a fractional weak discrepancy of $\max_{C \in \mathcal{C}} \frac{\text{up}(C)}{\text{side}(C)}$.

In addition to Theorem 53 which provides combinatorial certification for $\text{wd}(P) \leq k$, the following theorem, which is implicit in the work of Choi and West [4], will be key in characterizing the (d, d) -irreducible posets.

Theorem 54. *A poset P on n points is d -weak-discrepancy irreducible if and only if every forcing cycle C that is maximal with respect to $\frac{\text{up}(C)}{\text{side}(C)}$ has size t side steps and $(d-1)t + 1$ up steps and $n = t + (d-1)t + 1$.*

5.4 (d, d) -irreducible Posets

Let \mathcal{W}_d be the collection of d -weak-discrepancy-irreducible posets where there exists a maximal forcing cycle with all the up steps consecutive, in particular, there exists a forcing cycle $C = a_1, a_2, \dots, a_{(d-1)t+2}, b_1, b_2, \dots, b_{t-1}$ using all the elements where

$a_i < a_j$ if $i < j$, $b_j \parallel b_{j+1}$ for $1 \leq j \leq t-2$, $a_{(d-1)t+2} \parallel b_1$, $a_1 \parallel b_{t-1}$. We claim that \mathcal{W}_d is the set of all (d, d) -irreducible posets. First we show that all elements of \mathcal{W}_d are (d, d) -irreducible. Since the elements of \mathcal{W}_d are d -weak-discrepancy-irreducible by construction, it suffices to show that they all have linear discrepancy d .

Lemma 55. *If $W \in \mathcal{W}_d$, then $\text{ld}(W) = d$.*

Proof. Let $W \in \mathcal{W}_d$ have $td + 1$ points and let $C = a_0 < c_1^1 < c_1^2 < \dots < c_1^{d-1} < c_2^1 < \dots < c_2^{d-1} < \dots < c_t^1 < \dots < c_t^{d-1} < a_t \parallel a_{t-1} \parallel a_{t-2} \parallel \dots \parallel a_1$ be the optimal forcing cycle. Now since W is d -weak-discrepancy irreducible, let f be the function witnessing the optimal fractional weak discrepancy of $(d-1) + \frac{1}{t}$ as provided in Theorem 53. In particular, $f(a_i) = (d-1 + \frac{1}{t})i$ and $f(c_i^j) = (i-1)(d-1) + j$. Define the function $g : W \rightarrow \{0, \dots, dt\}$ by $g(a_i) = di$ and $g(c_i^j) = (i-1)d + j$. We claim g is an order preserving map of W witnessing linear discrepancy at most d . First we observe that by construction if $g(x) = g(y)$, then $x = y$. Now if $f(a_i) < f(c_i^j)$, then

$$\begin{aligned} \left\lceil \frac{f(a_i)}{d-1} \right\rceil &\leq \left\lceil \frac{f(c_i^j)}{d-1} \right\rceil \\ \left\lceil \frac{(d-1 + \frac{1}{t})i}{d-1} \right\rceil &\leq \left\lceil \frac{(\hat{i}-1)(d-1) + j}{d-1} \right\rceil \\ \left\lceil i + \frac{i}{t(d-1)} \right\rceil &\leq \left\lceil \hat{i} - 1 + \frac{j}{d-1} \right\rceil \\ i + 1 &\leq \hat{i}. \end{aligned}$$

Thus $i < \hat{i}$ so $g(a_i) < g(c_i^j)$. Similarly, if $f(c_i^j) < f(a_i)$, then

$$\begin{aligned} \frac{f(c_i^j)}{d-1} &< \frac{f(a_i)}{d-1} \\ \hat{i} - 1 + \frac{j}{d-1} &< i + \frac{i}{t(d-1)} \\ \hat{i} - 1 + \frac{tj - i}{t(d-1)} &< i. \end{aligned}$$

But then, since $tj \geq i$, we have $\hat{i} - 1 < i$ and hence $g(c_i^j) < g(a_i)$. Thus since f is a weak extension and for any $x, y \in W$ if $f(x) < f(y)$, then $g(x) < g(y)$, then g is a

weak order preserving map of W . But, since g is one-to-one, this implies that g is an order preserving map of W .

Now suppose $x \parallel y$ and $|g(x) - g(y)| > d$. If $x, y \in \{a_0, a_1, \dots, a_t\}$, then $|g(x) - g(y)| > d$ implies that the indices of x and y differ by at least two and hence $|f(x) - f(y)| \geq 2(d - 1 + \frac{1}{t})$ and so x and y are comparable since f witnesses fractional weak discrepancy at most $d - 1 + \frac{1}{t}$. Thus precisely one of $\{x, y\}$ is a point of the form c_i^j , and the other is a point of the form a_k with $1 \leq k \leq t - 1$. We will show that if $|g(c_i^j) - g(a_k)| > d$, then c_i^j and a_k are comparable. In particular, we wish to show that if $g(c_i^j) - g(a_k) > d$, then $c_i^j > a_k$, and if $g(a_k) - g(c_i^j) > d$, then $a_k > c_i^j$. Since the c_i^j form a chain, it suffices to consider the minimal c_i^j such that $g(c_i^j) - g(a_k) > d$ and the maximal c_i^j such that $g(a_k) - g(c_i^j) > d$. We note that

$$\begin{aligned} |g(a_k) - g(c_i^j)| &= |dk - (i - 1)d - j| \\ &= |d(k - i + 1) - j| \\ &\leq d|k - i + 1| + j \\ &\leq d|k - i + 1| + (d - 1). \end{aligned}$$

Thus, if $g(c_i^j) - g(a_k) > d$, then $i \geq k + 2$, and if $g(a_k) - g(c_i^j) > d$, then $i \leq k$. However, for $i = k$ we have

$$|g(a_k) - g(c_i^j)| = |d - j| < d.$$

Thus we need only consider $i < k$. Since $g(c_{k+2}^1) - g(a_k) = d + 1 = g(a_k) - g(c_{k-1}^{d-1})$ it suffices to only consider c_{k+2}^1 and c_{k-1}^{d-1} . Now observe that c_{k+2}^1 exists only if $k \leq t - 2$, we have

$$\begin{aligned} f(c_{k+2}^1) - f(a_k) &= (k + 1)(d - 1) + 1 - (d - 1)k + \frac{k}{t} \\ &= (d - 1) + \frac{t - k}{t} \\ &> (d - 1) + \frac{1}{t}. \end{aligned}$$

Thus $a_k < c_{k+2}^1$ since f witnesses fractional weak discrepancy at most $d - 1 + \frac{1}{t}$. Similarly, c_{k-1}^{d-1} exists only if $k \geq 2$ and then

$$\begin{aligned} f(a_k) - f(c_{k-1}^{d-1}) &= (d-1)k + \frac{k}{t} - (k-2)(d-1) - (d-1) \\ &= (d-1) + \frac{k}{t} \\ &> (d-1) + \frac{1}{t}. \end{aligned}$$

Thus $c_{k-1}^{d-1} < a_k$ and hence g is an order preserving map of W that witnesses linear discrepancy at most d . But then since $d = \text{wd}(W) \leq \text{ld}(W) \leq d$, the linear discrepancy of W is exactly d . \square

The following theorem shows that not only are all elements of \mathcal{W}_d (d, d) -irreducible, every (d, d) -irreducible poset is a member of \mathcal{W}_d .

Theorem 56. *Let P be a poset with $\text{ld}(P) = d$. Then $\text{wd}(P) = d$ if and only if there exists a subposet W of P such that $W \in \mathcal{W}_d$.*

Proof. First suppose there is some subposet W of P such that $W \in \mathcal{W}_d$. Then since $d = \text{ld}(P) \geq \text{wd}(P) \geq \text{wd}(W) = d$, we have $\text{wd}(P) = d$.

Suppose then that $\text{ld}(P) = \text{wd}(P) = d$. Then it is clear that there is some subposet W' of P such that W' is (d, d) -irreducible. Now since the removal of any point from W' decreases either the weak discrepancy or the linear discrepancy and $\text{wd}(P) \leq \text{ld}(P)$ for all P , we know that W' is d -weak-discrepancy irreducible. Thus it suffices to show that the maximal forcing cycle has all the up steps consecutive.

Since W' is d -weak-discrepancy irreducible, $|W'| = dt + 1$ for some t , and there is a maximal forcing cycle C using $dt + 1$ points. This forcing cycle naturally partitions the elements of W' into chains C_1, C_2, \dots, C_t by using the side steps as break points in the chain. For all chains C_i , let a_i be the minimal element and let b_i be the maximal element (note that it is not necessarily the case that $a_i \neq b_i$). We say that a side move

$(b, a) \in \{(b_i, a_{i+1}) \mid 1 \leq i \leq t-1\} \cup \{(b_t, a_1)\}$, *encompasses* a point x with respect to a linear extension L if $b <_L x <_L a$ or $a <_L x <_L b$.

Fix an arbitrary linear extension L of W' . Suppose $x \in C_i$ and $a_i \leq x < b_i$ (and hence x is not in a trivial chain) and x is not encompassed by any side move. Then, since $x < b_i$, by traversing the cycle we can conclude that $x \leq_L a_j$ for any $1 \leq j \leq t$. But then $x \leq_L y$ for any $y \in W'$ and hence is the minimum element of L . Similarly if $a_i < x \leq b_i$, then x is the maximum element of L . Thus the only elements of P that are not encompassed by a side step with respect to L are the minimum and maximum elements of L and the elements belonging to a trivial chain. Now let \mathcal{T} be the set of trivial chains. Then, as there are t side steps, there exists some side move (b_L, a_L) encompassing at least $\left\lceil \frac{dt+1-(2+|\mathcal{T}|)}{t} \right\rceil = d - \left\lfloor \frac{1+|\mathcal{T}|}{t} \right\rfloor$ elements in the linear extension L . Thus if $|\mathcal{T}| < t-1$, then (b_L, a_L) encompasses at least d elements with respect to L , and hence $|h_L(b_L) - h_L(a_L)| \geq d+1$. But since L was an arbitrary linear extension, this implies that $\text{ld}(W') \geq d+1$, a contradiction. Thus $|\mathcal{T}| = t-1$ and so all but one of the chains are trivial, and hence all the up steps are consecutive in the forcing cycle. \square

5.5 Characterization of \mathcal{W}_d

In examining the nature of \mathcal{W}_d , it is clear that, contrary to most results on posets, \mathcal{W}_d is specified through explicit local restrictions on the set of comparabilities and incomparabilities rather than global restriction on the structure of the poset. That is, \mathcal{W}_d is defined as the set of solutions to a collection of transitively oriented sandwich problems [10] where the order among some pairs of elements are defined and other pairs of points are defined to be incomparable. However, we can exploit the structure of elements of \mathcal{W}_d to provide a more natural description of the class as interval orders. This characterization of \mathcal{W}_d as a collection of interval orders joins with results such as the forbidden subposet characterization of posets with linear discrepancy at most

two [11, 12], the NP-completeness of linear discrepancy [6], and the behavior of online algorithms for linear discrepancy [16] in emphasizing the centrality of interval orders in the study of linear and weak discrepancy.

Let $W \in \mathcal{W}_d$ and let $C = a_0 < c_1^1 < c_1^2 < \cdots < c_1^{d-1} < c_2^1 < \cdots < c_2^{d-1} < \cdots < c_t^1 < \cdots < c_t^{d-1} < a_t \parallel a_{t-1} \parallel a_{t-2} \parallel \cdots \parallel a_1$ be an optimal forcing cycle of W . We first note that if $a_i < a_j$, then $a_i < c_{i+2}^1$ and $c_{j-1}^{d-1} < a_j$. But then, since $j \geq i + 2$, this implies that every element of the chain $a_0 < c_1^1 < \cdots < c_t^{d-1} < a_t$ is comparable to either a_i or a_j . Thus W does not contain a $\mathbf{2} + \mathbf{2}$ and hence is an interval order. Now in order to characterize the elements of \mathcal{W}_d , it suffices to provide a collection of intervals or rules for generating the intervals that will realize every element of \mathcal{W}_d . We note that since $a_i < a_j$ implies that every element of the chain $a_0 < c_1^1 < c_1^2 < \cdots < c_1^{d-1} < c_2^1 < \cdots < c_2^{d-1} < \cdots < c_t^1 < \cdots < c_t^{d-1} < a_t$ is comparable to either a_i or a_j , we may assume that the intervals associated with the long chain are degenerate. In particular, we assume that the interval for c_i^j is $\{(i-1)d + j\}$ and that the intervals for a_0 and a_t are $\{0\}$ and $\{dt\}$, respectively.

Now for $1 \leq i \leq t-1$, let the endpoints of the interval associated with a_i be ℓ_i and r_i . Using that c_i^j is assigned to the degenerate interval $\{(i-1)d + j\}$, it is clear that we may assume for $1 \leq i \leq t-1$, $[\ell_i, r_i] \subseteq (d(i-1) - 1, d(i+1) + 1)$. The constraints $a_i \parallel a_{i+1}$ and $a_i < a_{i+2}$ force $\ell_{i+1} < r_i < \ell_{i+2}$. In fact, any interlaced sequence $-1 < \ell_2 < r_1 < \ell_3 \cdots < \ell_t < r_{t-1} < dt + 1$ such that $r_i < d(i+1) + 1$ for $1 \leq i < t-1$ and $d(j-1) - 1 < \ell_j$ for $1 < j \leq t$ will yield an interval representation of an element of \mathcal{W}_d . For example, see Figure 30.

5.6 Conclusion and Future Work

Determining linear discrepancy, in general, is a difficult task while determining weak discrepancy takes polynomial time in the number of points for a poset. This makes finding relations between the two properties difficult. Still it is natural to ask if

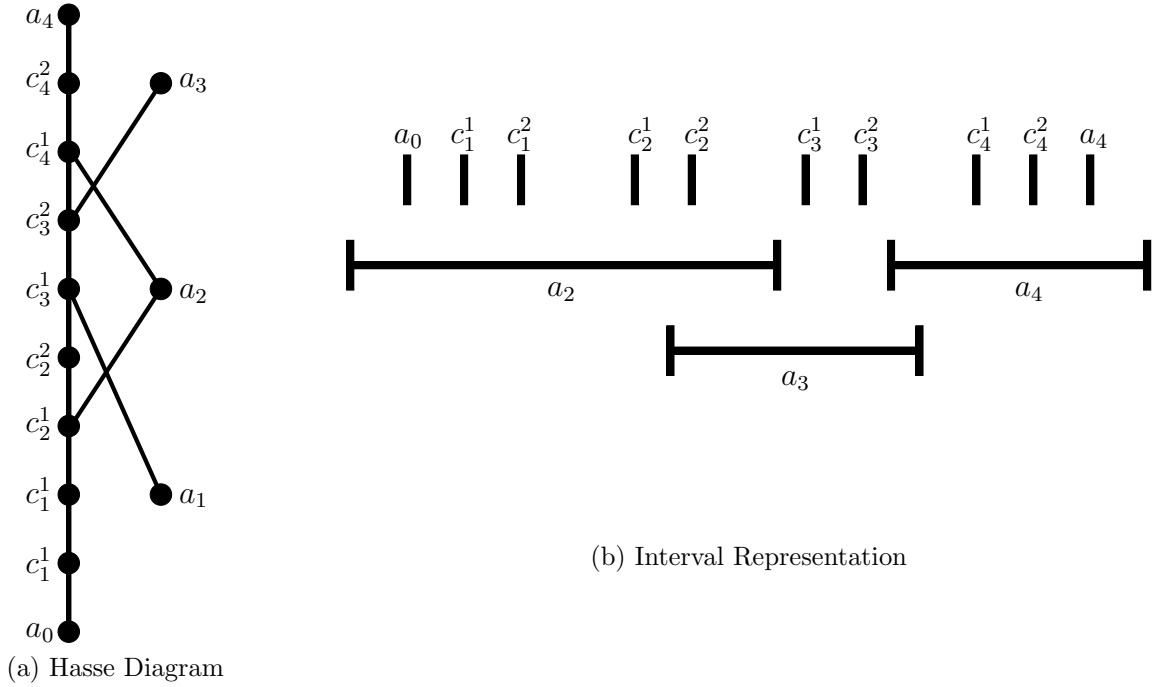

Figure 30: A element of \mathcal{W}_3 on 13 points.

there are any relationships between these discrepancies. In general, bounding weak discrepancy does not bound the size of linear discrepancy as an antichain has weak discrepancy zero, but the linear discrepancy is the size of the antichain minus one. If, however, the width of a poset is bounded then the linear discrepancy can be bounded by a function of its weak discrepancy. As another possibility, instead of bounding the width, the size of an element's incomparable set could be bounded. Additionally, such a bound may possibly be modified to give a bound on the t -discrepancy of a poset for any given t .

Another question is what are the structure of posets that have weak discrepancy close to linear discrepancy. For example, which posets have $ld(\mathbf{P}) = wd(\mathbf{P} + 1)$ or $ld(\mathbf{P}) = wd(\mathbf{P} + 2)$? Are these posets similar in nature to \mathcal{W}_d or can they be widely different?

CHAPTER VI

CONCLUSION

Discrepancy in posets has become a well studied property for posets. However, there are still many questions yet to be answered. One such question is the relationship between linear discrepancy and dimension of a poset. There is a brief argument that says a poset's dimension is less than or equal to its width. Linear discrepancy is at least the width of a poset minus one since an antichain of size n has linear discrepancy $n - 1$. This gives a bound that linear discrepancy is always greater than dimension minus one. Furthermore, this bound is tight as the two examples from Figure 31 show. We leave it to the reader to see that the two examples have dimension 3 and 4, and the linear discrepancies are 2 and 3 respectively. The question though is whether this bound is tight for higher n . The standard example of dimension n has linear discrepancy n as well and thus it has been conjectured that if a poset \mathbf{P} has dimension $n \geq 5$ then the linear discrepancy of \mathbf{P} is at least as large as its dimension.

As previously mentioned there are a number of approximation questions that are unanswered for estimating linear discrepancy, only for a few special classes of posets has the linear discrepancy of a poset been determined. Two possible ideas for this estimation are to show that a height-ordered extension (an extension that witnesses total linear discrepancy) may give a reasonable approximation of linear discrepancy. Another idea is to use a Monte Carlo scheme where a near random sampling of linear extensions is taken and one can guarantee a certain factor of approximation (such a sampling has been given in Brightwell [2]). In this simulation the question is how many samples are needed to essentially guarantee, within a close factor, an approximation of the linear discrepancy value.

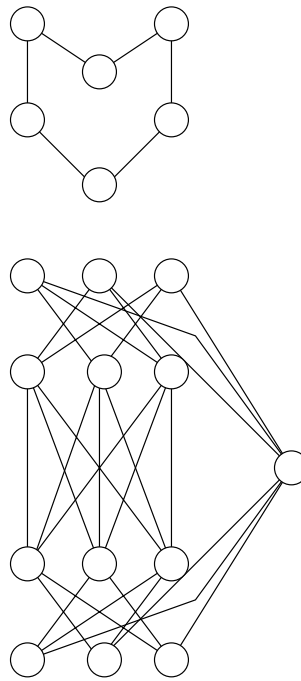

Figure 31: Two posets that have dimension larger than the linear discrepancy

REFERENCES

- [1] BRIGHTWELL, G. and PATEL, V., “Average relational distance in linear extensions of posets.” Submitted, 2009.
- [2] BRIGHTWELL, G. and WINKLER, P., “Counting linear extensions,” *Order*, vol. 8, no. 3, pp. 225–242, 1991.
- [3] CHAE, G.-B., CHEONG, M., and KIM, S.-M., “Irreducible posets of linear discrepancy 1 and 2,” *Far East J. Math. Sci. (FJMS)*, vol. 22, no. 2, pp. 217–226, 2006.
- [4] CHOI, J. and WEST, D. B., “Forbidden subposets for fractional weak discrepancy at most k .” Accepted pending revision, 2009.
- [5] FISHBURN, P. C., *Interval orders and interval graphs*. Wiley-Interscience Series in Discrete Mathematics, Chichester: John Wiley & Sons Ltd., 1985. A study of partially ordered sets, A Wiley-Interscience Publication.
- [6] FISHBURN, P. C., TANENBAUM, P. J., and TRENK, A. N., “Linear discrepancy and bandwidth,” *Order*, vol. 18, no. 3, pp. 237–245, 2001.
- [7] GARDI, F., “The Roberts characterization of proper and unit interval graphs,” *Discrete Math.*, vol. 307, no. 22, pp. 2906–2908, 2007.
- [8] GIMBEL, J. G. and TRENK, A. N., “On the weakness of an ordered set,” *SIAM J. Discrete Math.*, vol. 11, no. 4, pp. 655–663 (electronic), 1998.
- [9] GOLUMBIC, M. C. and TRENK, A. N., *Tolerance graphs*, vol. 89 of *Cambridge Studies in Advanced Mathematics*. Cambridge: Cambridge University Press, 2004.
- [10] HABIB, M., KELLY, D., LEBHAR, E., and PAUL, C., “Can transitive orientation make sandwich problems easier?,” *Discrete Math.*, vol. 307, no. 16, pp. 2030–2041, 2007.
- [11] HOWARD, D., CHAE, G.-B., CHEONG, M., and KIM, S.-M., “Irreducible width 2 posets of linear discrepancy 3,” *Order*, vol. 25, no. 2, pp. 105–119, 2008.
- [12] HOWARD, D., KELLER, M. T., and YOUNG, S. J., “A characterization of partially ordered sets with linear discrepancy equal to 2,” *Order*, vol. 24, no. 3, pp. 139–153, 2007.
- [13] HOWARD, D., SHULL, R., STREIB, N., and TRENK, A. N., “The total linear discrepancy of an ordered set,” To appear in *Discrete Math*, 2009.

- [14] HOWARD, D. and TRENK, A. N., “The t-discrepancy of a poset.” Submitted, 2009.
- [15] HOWARD, D. and YOUNG, S., “When linear and weak discrepancy are equal.” Submitted, 2009.
- [16] KELLER, M. T., STREIB, N., and TROTTER, W. T., “Online linear discrepancy.” in preperation, 2009.
- [17] KELLER, M. T. and YOUNG, S. J., “Degree bounds for linear discrepancy of interval orders and disconnected posets.” Submitted, 2009.
- [18] KLEITMAN, D. J. and VOHRA, R. V., “Computing the bandwidth of interval graphs,” *SIAM J. Discrete Math.*, vol. 3, no. 3, pp. 373–375, 1990.
- [19] KLOKS, T., KRATSCH, D., and MÜLLER, H., “Approximating the bandwidth for asteroidal triple-free graphs,” *J. Algorithms*, vol. 32, no. 1, pp. 41–57, 1999.
- [20] KLOKS, T., KRATSCH, D., and MÜLLER, H., “Approximating the bandwidth for asteroidal triple-free graphs,” *J. Algorithms*, vol. 32, no. 1, pp. 41–57, 1999.
- [21] SCOTT, D. and SUPPES, P., “Foundational aspects of theories of measurement,” *J. Symb. Logic*, vol. 23, pp. 113–128, 1958.
- [22] SHULL, R. and TRENK, A. N., “Total linear discrepancy for the sum of two chains,” Tech. Rep. CSD-TR-35-2009, Department of Computer Science Technical Report, Wellesley College, 2009.
- [23] TANENBAUM, P. J., TRENK, A. N., and FISHBURN, P. C., “Linear discrepancy and weak discrepancy of partially ordered sets,” *Order*, vol. 18, no. 3, pp. 201–225, 2001.
- [24] TRENK, A. N., “On k -weak orders: recognition and a tolerance result,” *Discrete Math.*, vol. 181, no. 1-3, pp. 223–237, 1998.
- [25] TROTTER, W. T., *Combinatorics and partially ordered sets*. Johns Hopkins Series in the Mathematical Sciences, Baltimore, MD: Johns Hopkins University Press, 1992. Dimension theory.