

FINAL REPORT

ENTITLED

LABORATORY EVALUATION AND APPLICATION OF
MICROWAVE ABSORPTION PROPERTIES UNDER
SIMULATED CONDITIONS FOR PLANETARY ATMOSPHERES

to the

Planetary Atmospheres Program of the
National Aeronautics and Space Administration
for Grant NAGW-533

Principal Investigator:

Paul G. Steffes

School of Electrical and Computer Engineering

Georgia Institute of Technology

Atlanta, Georgia 30332-0250

Tel: (404) 894-3128

Fax: (404) 894-4641

e-mail: ps11@prism.gatech.edu

Report Period: February 1, 1984 through December 31, 1996

Submitted: March 1997

TABLE OF CONTENTS

COVER PAGES:

	<u>Page</u>
A. Cover Sheet	i
B. Table of Contents	ii
I. INTRODUCTION AND SUMMARY	1
II. PROGRESS REPORT	1
III. STUDENTS SUPPORTED BY THIS PROJECT	2
IV. PUBLICATIONS	3
V. CONCLUSIONS	12
VI. APPENDICES	13

I. INTRODUCTION AND SUMMARY

Radio absorptivity data for planetary atmospheres obtained from spacecraft radio occultation experiments and earth-based radio astronomical observations can be used to infer abundances of microwave absorbing constituents in those atmospheres, as long as reliable information regarding the microwave absorbing properties of potential constituents is available. The use of theoretically-derived microwave absorption properties for such atmospheric constituents, or using laboratory measurements of such properties under environmental conditions which are significantly different than those of the planetary atmosphere being studied, often leads to significant misinterpretation of available opacity data. Laboratory measurements completed under this grant (NAGW-533), have shown that the opacity from, SO₂ under simulated Venus conditions is best described by a different lineshape than was previously used in theoretical predictions. The recognition of the need to make such laboratory measurements of simulated planetary atmospheres over a range of temperatures and pressures which correspond to the altitudes probed by both radio occultation experiments and radio astronomical observations, and over a range of frequencies which correspond to those used in both radio occultation experiments and radio astronomical observations, has led to the development of a facility at Georgia Tech which is capable of making such measurements. It has been the goal of this investigation to conduct such measurements and to apply the results to a wide range of planetary observations, both spacecraft and earth-based, in order to determine the identity and abundance profiles of constituents in those planetary atmospheres.

II. PROGRESS REPORT

This project represents an ongoing activity (since February 1984) to conduct laboratory measurements of the microwave and millimeter-wave properties of simulated planetary atmospheres, in support of NASA missions and ground-based microwave and millimeter-wave observations of planetary atmospheres. The project has also included application of the laboratory results to data from missions and earth-based observations, as well as direct involvement in mission-based microwave measurements (e.g., Magellan atmospheric radio occultation studies) and earth-based measurements (e.g., mapping of Venus with the NRAO/VLA). A renewal project for FY97 funding for this project (November 1, 1996 through October 31, 1997) was submitted to the NASA Planetary Atmospheres Program in July 1996, and has been selected for funding in FY 1997. However, due to the imminent transfer of the grants office at NASA Headquarters, the renewal will be in the form of a new grant issued from the NASA Goddard Space Flight Center, hence, the submission of the Final Report for this grant (NAGW-533).

The technical progress of this project has been described in 22 Progress/Status Reports submitted since 1984. Copies of all reports are available through the NASA Center for AeroSpace Information (NASA-CASI) and are on file at the Planetary Atmospheres Program Office. The current technical status of the project is described in the recent Renewal Proposal and Progress Report #22, which is attached as Appendix A.

III. Students Supported

Over the course of this project, numerous students have been supported as graduate and undergraduate research assistants (see Table I). Additionally, a significant number of student projects, conducted for academic credit, were completed. Nearly every student was involved in the publication of papers in either refereed journals or at conferences, such as AAS/DPS. (See Section IV.) Of the seven Ph.D. students supported by this grant, two have gone on to permanent research positions in planetary and space sciences. Three others have gone to permanent positions in earth atmospheric remote sensing, and two more have taken (or will take) industry positions in space telecommunications. Titles of the Ph.D. dissertations are included in Section IV. of this report.

TABLE I.

Students Supported by Grant NAGW-533

Ph.D.

David R. DeBoer
Antoine K. Fahd
Jon M. Jenkins
Joanna Joiner
Marc A. Kolodner
Shady H. Suleiman
Scott Borgsmiller

M.S.

William Gregory
Gregory Gurski
George O. Hirvela
Jon M. Jenkins
Joanna Joiner
David G. Lashley
Patrick Stelitano
David Watson

B.S.

William Gregory
Jon M. Jenkins
Joanna Joiner
R. Christopher Lott

IV. PUBLICATIONS

The following theses, journal publications, and conference presentations were supported (or partially supported) by Grant NAGW-533.

Ph.D. Dissertations/Theses

J. Joiner, "Millimeter-Wave Spectra of the Jovian Planets," Ph.D. Dissertation, Georgia Institute of Technology, August 1991.

J. M. Jenkins, "Variations in the 13 cm Opacity below the Main Cloud Layer in the Atmosphere of Venus Inferred from Pioneer-Venus Radio Occultation Studied: 1978 - 1987," Ph.D. Dissertation, Georgia Institute of Technology, March 1992.

A. K. Fahd, "Study and Interpretation of the Millimeter-Wave Spectrum of Venus," Ph.D. Dissertation, Georgia Institute of Technology, June 1992.

D. R. DeBoer, "The Microwave Opacity of H₂S with Applications to the Tropospheric Vertical Structure of the Jovian Planets," Ph.D. Dissertation, Georgia Institute of Technology, April 1995.

S. H. Suleiman, "Microwave Effects of Gaseous Sulfuric Dioxide (SO₂) in the Atmosphere of Venus and Earth," Ph.D. Dissertation, Georgia Institute of Technology, expected May 1997.

M. A. Kolodner, "Microwave Remote Sensing of Sulfuric Acid Vapor in the Venus Atmosphere," Ph.D. Dissertation, Georgia Institute of Technology, expected May 1997.

Journal Publications

P. G. Steffes, "Laboratory Measurements of the Microwave Opacity and Vapor Pressure of Sulfuric Acid Under Simulated Conditions for the Middle Atmosphere of Venus," *Icarus*, vol. 64, pp. 576-585, December 1985.

P. G. Steffes, "Evaluation of the Microwave Spectrum of Venus in the 1.2 to 22 cm Wavelength Range Based on Laboratory Measurements of Constituent Gas Opacities," *Astrophysical Journal*, vol. 310, pp. 482-489, November 1, 1986.

P. G. Steffes and J. M. Jenkins, "Laboratory Measurements of the Microwave Opacity of Gaseous Ammonia (NH₃) Under Simulated Conditions for the Jovian Atmosphere," Icarus, vol. 52, pp. 35-47, October 1987.

J. M. Jenkins and P. G. Steffes, "Constraints on the Microwave Opacity of Gaseous Methane and Water Vapor in the Jovian Atmosphere," Icarus, vol. 76, December 1988.

J. Joiner, P. G. Steffes, and J. M. Jenkins, "Laboratory Measurements of the 7.5-9.38 mm Absorption of Gaseous Ammonia (NH₃) Under Simulated Jovian Conditions," Icarus, vol. 81, pp. 386-395, 1989.

P. G. Steffes, M. J. Klein, and J. M. Jenkins, "Observation of the Microwave Emission of Venus from 1.3 to 3.6 cm," Icarus, vol. 84, pp. 83-92, March 1990.

J. M. Jenkins and P. G. Steffes, "Results for 13 cm Absorptivity and H₂SO₄ Abundance Profiles from the Season 10 (1986) Pioneer-Venus Orbiter Radio Occultation Experiment," Icarus, vol. 90, pp. 129-138, March 1991.

A. K. Fahd and P. G. Steffes, "Laboratory Measurement of the Millimeter-Wave Properties of Liquid Sulfuric Acid (H₂SO₄)," Journal of Geophysical Research (Planets), vol. 96, pp. 17,471-17,476, September 25, 1991.

J. Joiner and P. G. Steffes, "Modeling of the Millimeter-Wave Emission of Jupiter Utilizing Laboratory Measurements of Ammonia (NH₃) Opacity," Journal of Geophysical Research (Planets), vol. 96, pp. 17,463-17,470, September 25, 1991.

A. K. Fahd and P. G. Steffes, "Laboratory Measurements of the Microwave and Millimeter-Wave Opacity of Gaseous Sulfur Dioxide (SO₂) under Simulated Conditions for the Venus Atmosphere," Icarus, vol. 97, pp. 200-210, June 1992.

A.J. Gasiewski and P.G. Steffes, "University Profile: The Laboratory for Radioscience and Remote Sensing at the Georgia Institute of Technology," IEEE Geoscience and Remote Sensing Society Newsletter, vol. 88, pp. 16-21, September 1993.

J. Joiner, P. G. Steffes, and K. S. Noll, "Search for Sulfur (H₂S) on Jupiter at Millimeter Wavelengths," IEEE Transactions on Microwave Theory and Techniques, vol. 40, pp. 1101-1109, June 1992.

D. R. DeBoer, and P.G. Steffes, "Laboratory Measurements of the Microwave Properties of H₂S under Simulated Jovian Conditions with an Application to Neptune", Icarus, Vol. 109, pp. 352-366, June 1994.

P. G. Steffes, J. M. Jenkins, R. S. Austin, S. W. Asmar, D. T. Lyons, E. H. Seale, and G. L. Tyler, "Radio Occultation Studies of the Venus Atmosphere with the Magellan Spacecraft. 1. Experiment Description and Performance," Icarus, vol. 110, pg. 71-78, July 1994.

J. M. Jenkins, P. G. Steffes, J. Twicken, D. P. Hinson, and G. L. Tyler, "Radio Occultation Studies of the Venus Atmosphere with the Magellan Spacecraft 2. Results from the October 1991 Experiment" Icarus, vol. 110, pg. 79-94, July 1994.

D. R. DeBoer and P. G. Steffes, "The Georgia Tech High Sensitivity Microwave Measurement System," Astrophysics and Space Science, Vol. 236, pp. 111-124, February 1996.

S. H. Suleiman, M. A. Kolodner, and P. G. Steffes, "Laboratory Measurement of the Temperature Dependence of Gaseous Sulfur Dioxide (SO₂) Microwave Absorption with Application to the Venus Atmosphere," Journal of Geophysical Research, Vol. 101, Number E2, pp. 4623-4635, February 1996.

D. R. DeBoer and P. G. Steffes, "Estimates of the Tropospheric Vertical Structure of Neptune Based on Microwave Radiative Transfer Studies," Icarus, vol. 123, pp. 324-335, October 1996.

Conference Presentations with Published Proceedings or Abstracts

P. G. Steffes and V. R. Eshleman, "Laboratory Measurements of the Microwave Opacity of Cloud Related Gases Under Simulated Conditions for the Venus Atmosphere," Bulletin of the American Astronomical Society, vol. 13, pg. 716, 1981.

P. G. Steffes, P. S. Stellitano, and R. C. Lott, "Measurements of the Microwave Opacity and Vapor Pressure of Gaseous Sulfuric Acid Under Simulated Venus Conditions," Bulletin of the American Astronomical Society, vol. 16, pg. 694, 1984. This paper was presented at the 16th Annual Meeting of the American Astronomical Society, Kona, Hawaii, October 1984.

P. G. Steffes, "Laboratory Measurements of Microwave Absorption from Gaseous Constituents Under Conditions for the Outer Planets," presented at the Conference on the Jovian Atmospheres, New York, published in The Jovian Atmospheres, NASA Conference Publication 2441, pp. 111- 116, May 1985.

P. G. Steffes, "Microwave Absorption from Cloud-Related Gases in Planetary Atmospheres," Proceedings of the 1985 Joint Assembly of the International Association of Meteorology and Atmospheric Physics (IAMAP) and the International Association of Physical Sciences of the Ocean (IAPSO), Paper No. M10- 13, pg. 96, August 1985. (invited)

P. G. Steffes and D. H. Watson, "Constraints on Constituent Abundances in the Venus Atmosphere from the Microwave Emission Spectrum in the 1 to 20 cm Wavelength Range," Bulletin of the

American Astronomical Society, vol. 17, pg. 720, 1985. Presented at the 17th Annual Meeting of the Division of Planetary Sciences of the American Astronomical Society, Baltimore, Maryland, October 1985.

P. G. Steffes, "Microwave Properties of the Atmospheres of the Outer Planets: Laboratory Measurements with the Georgia Tech Planetary Atmospheres Simulator," Proceedings of the Laboratory Measurements for Planetary Science Workshop, Meudon, France, pg. L-6, November 3, 1986.

P. G. Steffes, J. M. Jenkins, M. F. Selman, and W. W. Gregory, "Laboratory Measurements of the Microwave Opacity of Gaseous Ammonia (NH₃) Under Simulated Conditions for Jovian Atmospheres," Bulletin of the American Astronomical Society, vol. 18, pg. 787, 1986. Presented at the 18th Annual Meeting of the Division of Planetary Sciences of the American Astronomical Society, France, November 5, 1986.

P. G. Steffes, "Laboratory Measurements of the Millimeter-Wave Absorption from Gaseous Constituents Under Simulated Conditions for the Outer Planets," Proceedings of the Laboratory Measurements for Planetary Science II Workshop, Pasadena, California, pp. 6-7 through 6-8, November 9, 1987.

J. M. Jenkins and P. G. Steffes, "Limits of the Microwave Absorption of H₂O and CH₄ in the Jovian Atmosphere," Bulletin of the American Astronomical Society, vol. 19, pg. 695, 1987. Presented at the 19th Annual Meeting of the Division of Planetary Sciences of the American Astronomical Society, Pasadena, California, November 11, 1987.

J. Joiner, J. M. Jenkins, and P. G. Steffes, "Laboratory Measurements of the Opacity of Gaseous Ammonia (NH₃) in the 7.3-8.3 mm (36-41 GHz) Range Under Simulated Conditions for Jovian Atmospheres," Bulletin of the American Astronomical Society, vol. 19, pg. 694, 1987. Presented at the 19th Annual Meeting of the Division of Planetary Sciences of the American Astronomical Society, Pasadena, California, November 11, 1987.

P. G. Steffes, J. M. Jenkins, and M. J. Klein, "Observation of the Microwave Emission Spectrum of Venus from 1.3 to 3.6 cm," Bulletin of the American Astronomical Society, vol. 19, pg. 780, 1987. Presented at the 19th Annual Meeting of the Division of Planetary Sciences of the American Astronomical Society, Pasadena, California, November 11, 1987.

J. Joiner, J. M. Jenkins, and P. G. Steffes, "Millimeter-Wave Measurements of the Opacity of Gaseous Ammonia (NH₃) Under Simulated Conditions for the Jovian Atmosphere," Bulletin of the American Astronomical Society, vol. 20, pg. 867, 1988. Presented at the 20th Annual Meeting of the Division of Planetary Sciences of the American Astronomical Society, Austin, Texas, November 3, 1988.

P. G. Steffes, "Laboratory Measurements of Microwave and Millimeter-Wave Properties of Planetary Atmospheric Constituents," Laboratory Research for Planetary Atmospheres, NASA Conference Publication CP-3077, pp. 5-26, 1990. Presented at the First International Conference for Laboratory Research for Planetary Atmospheres, Bowie, Maryland, October 1989. (invited)

J. M. Jenkins and P. G. Steffes, "Potential Variability of the Abundance and Distribution of Gaseous Sulfuric Acid Vapor below the Main Cloud Deck in the Venus Atmosphere," Bulletin of the American Astronomical Society, vol. 21, pg. 925, 1989. Presented at the 21st Annual Meeting of the Division for Planetary Sciences of the American Astronomical Society, Providence, Rhode Island, October 31, 1989.

P. G. Steffes, "Evidence for Temporal Variations in SO₂ Abundance in the Sub-Cloud Region of the Venus Atmosphere," Bulletin of the American Astronomical Society, vol. 21, pg. 925, 1989. Presented at the 21st Annual Meeting of the Division for Planetary Sciences of the American Astronomical Society, Providence, Rhode Island, October 31, 1989.

A. K. Fahd and P. G. Steffes, "Laboratory Measurements of the Dissociation Factor of Gaseous Sulfuric Acid (H₂SO₄)," Bulletin of the American Astronomical Society, vol. 21, pg. 927, 1989. Presented at the 21st Annual Meeting of the Division for Planetary Sciences of the American Astronomical Society, Providence, Rhode Island, November 1, 1989.

J. Joiner and P. G. Steffes, "Models of the Millimeter-Wave Emission of the Jovian Atmosphere Utilizing Laboratory Measurements of Gaseous Ammonia (NH₃)," Bulletin of the American Astronomical Society, vol. 21, pg. 945, 1989. Presented at the 21st Annual Meeting of the Division for Planetary Sciences of the American Astronomical Society, Providence, Rhode Island, November 1, 1989.

A. K. Fahd and P. G. Steffes, "Laboratory Measurements of the 1.3 and 13.3 cm Opacity of Gaseous SO₂ under Simulated Conditions of the Middle Atmosphere of Venus," Bulletin of the American Astronomical Society, vol. 22, pg. 1032, 1990. Presented at the 22nd Annual Meeting of the Division for Planetary Sciences of the American Astronomical Society, Charlottesville, Virginia, October 22, 1990.

A. K. Fahd and P. G. Steffes, "Laboratory Measurement of the Millimeter-Wave Properties of Liquid Sulfuric Acid (H₂SO₄) Between 90 and 100 GHz," Bulletin of the American Astronomical Society, vol. 22, pg. 1035, 1990. Presented at the 22nd Annual Meeting of the Division for Planetary Sciences of the American Astronomical Society, Charlottesville, Virginia, October 22, 1990.

J. Joiner and P. G. Steffes, "Study of Millimeter-Wave Absorbing Constituents in the Jovian Atmospheres," Bulletin of the American Astronomical Society, vol. 22, pg. 1032, 1990. Presented at the 22nd Annual Meeting of the Division for Planetary Sciences of the American Astronomical Society, Charlottesville, Virginia, October 22, 1990.

J. M. Jenkins and P. G. Steffes, "Sulfuric Acid Vapor Profiles for the Atmosphere of Venus Below the Main Cloud Deck," Bulletin of the American Astronomical Society, vol. 22, pg. 1055, 1990. Presented at the 22nd Annual Meeting of the Division for Planetary Sciences of the American Astronomical Society, Charlottesville, Virginia, October 23, 1990.

P. G. Steffes and J. M. Jenkins, "Atmospheric Radio Occultation Measurements with Magellan at Venus," JPL Publication, JPL-D-8581, pp. B I-B8, 1991. Presented at the Magellan Atmospheric Science and Science Contingency Workshop, Pasadena, California, May 7, 1991.

A. K. Fahd and P. G. Steffes, "Laboratory Measurements of the Millimeter-Wave Opacity of Gaseous Sulfuric Acid (H₂SO₄) under Venus-Like Conditions," Program of the Third International Conference on Laboratory Research for Planetary Atmospheres. Presented at the Third International Conference on Laboratory Research for Planetary Atmospheres, Palo Alto, California, Paper SP-20, November 3, 1991.

A. K. Fahd and P. G. Steffes, "Laboratory Measurements of the Millimeter-Wave (3 mm) Opacity of Gaseous SO₂ under Simulated Conditions of the Middle Atmosphere of Venus," Bulletin of the American Astronomical Society, vol. 23, p. 1194, November 1991. Presented at the 23rd Meeting of the Division for Planetary Sciences of the American Astronomical Society, Palo Alto, California, November 6, 1991.

J. M. Jenkins and P. G. Steffes, "Comparison of Kalman and Wiener Filtering Techniques for Processing Pioneer Venus Radio Occultation Data," Bulletin of the American Astronomical Society, vol. 23, p. 1195, November 1991. Presented at the 23rd Meeting of the Division for Planetary Sciences of the American Astronomical Society, Palo Alto, California, November 6, 1991.

P. G. Steffes, J. M. Jenkins, R. S. Austin, G. L. Tyler, and E. H. Seale, "Radio Occultation Studies of the Venus Atmosphere with the Magellan Spacecraft," Bulletin of the American Astronomical Society, vol. 23, p. 1196, November 1991. Presented at the 23rd Meeting of the Division for Planetary Sciences of the American Astronomical Society, Palo Alto, California, November 6, 1991.

J. Joiner and P. G. Steffes, "Search for H₂S on Jupiter at Millimeter Wavelengths: Observations and Laboratory Measurements," Bulletin of the American Astronomical Society, vol. 23, p. 1135, November 1991. Presented at the 23rd Meeting of the Division for Planetary Sciences of the American Astronomical Society, Palo Alto, California, November 4, 1991.

A. K. Fahd and P. G. Steffes, "Understanding the Variation in the Millimeter-Wave Emission of Venus," International Colloquium on Venus, LPI Contribution No. 789, pp. 32-34, August 1992. Presented at the International Colloquium on Venus, Pasadena, California, August 10, 1992.

J. M. Jenkins and P. G. Steffes, "Long-Term, Variations in the Abundance and Distribution of Sulfuric Acid Vapor in the Venus Atmosphere Inferred from Pioneer Venus and Magellan Radio Occultation Studies," International Colloquium on Venus, LPI Contribution No. 789, pp. 50-51, August 1992. Presented at the International Colloquium on Venus, Pasadena, California, August 10, 1992.

P. G. Steffes, G.O. Hirvela, and D. G. Lashley, "Preliminary Results from Laboratory Measurements of the Centimeter Wavelength Opacity of Hydrogen Sulfide (H₂S) Under Simulated Conditions for the Outer Planets," Program of the Fourth International Conference on Laboratory Research for Planetary Atmospheres, pg. S 1, October 1992. Presented at the Fourth International Conference on Laboratory Research for Planetary Atmospheres, Munich, Germany, October 10-11, 1992.

P. G. Steffes, J. M. Jenkins, G. L. Tyler, J. Twicken, R. S. Austin, and S. W. Asmar, "Preliminary Results from the October 1991 Magellan Radio Occultation Experiment," Bulletin of the American Astronomical Society, vol. 24, pg. 1003, October 1992. Presented at the 24th Meeting of the Division for Planetary Sciences of the American Astronomical Society, Munich, Germany, October 19, 1992.

D. R. DeBoer and P. G. Steffes, "Laboratory Measurements of the Centimeter-Wave Characteristics of H₂S under Simulated Conditions for the Outer Planets." Program of the Fifth International Conference on Laboratory Research for Planetary Atmospheres, Boulder, CO, pg. SP-06, October 1993.

D. R. DeBoer and P. G. Steffes, "Effects of the Centimeter Wavelength Opacity of H₂S on Propagation and Emission in the Atmospheres of the Outer Planets." Bulletin of the American Astronomical Society, vol. 25, pg. 1080, October 1993. Presented at the 25th Annual Meeting of the Division for Planetary Sciences of the American Astronomical Society, Boulder, CO, October 20, 1993.

J. M. Jenkins, P. G. Steffes, J. Twicken, D. P. Hinson, and G. L. Tyler, "Atmospheric Profiles and Sulfuric Acid Vapor (H₂SO₄) Profiles from the October 1991 Magellan Orbiter Radio Occultation Experiments at Venus." Bulletin of the American Astronomical Society, vol. 25, pg. 1093, October, 1993. Presented at the 25th Annual Meeting of the Division for Planetary Sciences of the American Astronomical Society, Boulder, CO, October 20, 1993.

D.R. DeBoer and P.G. Steffes, "The Georgia Tech High Sensitivity Microwave Measurement System." Program of the Sixth International Conference on Laboratory Research for Planetary Atmospheres, pg. 28, October 1994. Presented at the Sixth International Conference on Laboratory Research for Planetary Atmospheres, Bethesda, MD, October 30, 1994.

M.A. Kolodner and P.G. Steffes, "On the Saturation Vapor Pressure of Sulfuric Acid (H₂SO₄)."
Program of the Sixth International Conference on Laboratory Research for Planetary Atmospheres,

pg. 35, October 1994. Presented at the Sixth International Conference on Laboratory Research for Planetary Atmospheres, Bethesda, MD, October 30, 1994.

S.H. Suleiman and P.G. Steffes, "Laboratory Measurement of the Temperature Dependence of Gaseous Sulfur Dioxide (SO₂) Microwave Absorption under Simulated Conditions for the Venus Atmosphere." Program of the Sixth International Conference on Laboratory Research for Planetary Atmospheres, pg. 29, October 1994. Presented at the Sixth International Conference on Laboratory Research for Planetary Atmospheres, Bethesda, MD, October 30, 1994.

D.R. DeBoer and P.G. Steffes, "Radiative Transfer Results from Neptune Microwave Emission." Bulletin of the American Astronomical Society, vol. 26, pg. 1094, October 1994. Presented at the 26th Annual Meeting of the Division for Planetary Sciences of the American Astronomical Society, Bethesda, MD, November 1, 1994.

P.G. Steffes, D.R. DeBoer, and W.W. Smith, "Observations of the Jovian Microwave (5cm) Emission During and Subsequent to the Collision with Comet Shoemaker-Levy 9." Bulletin of the American Astronomical Society, vol. 26, pg. 1586, December 1994. Presented at the 26th Annual Meeting of the Division for Planetary Sciences of the American Astronomical Society, Bethesda, MD, October 31, 1994.

M. A. Kolodner and P. G. Steffes, "New Laboratory Measurements of the Microwave Opacity of Sulfuric Acid under Simulated Venus Conditions." Bulletin of the American Astronomical Society, vol. 27, no.3, pp 1071-1072, October 1995. Presented at the 27th Annual Meeting of the Division for Planetary Sciences of the American Astronomical Society, Kona, HI, October 9, 1995.

S. H. Suleiman and P.G. Steffes, "Radiative Transfer Models for Venus Microwave and Millimeter-Wave Emission using a Ben-Reuven Formalism for SO₂ Absorption", Bulletin of the American Astronomical Society, vol 27, pg.1071, October 1995. Presented at the 27th Annual Meeting of the Division for Planetary Sciences of the American Astronomical Society, Kona, HI, October 9, 1995.

D. R. DeBoer and P. G. Steffes, "Potential Effect of Phosphine (PH₃) on the Microwave and Millimeter Wave Opacity and Emission from the Atmosphere of Neptune", Bulletin of the American Astronomical Society, vol. 27, pg. 1087, October 1995. Presented at the 27th Annual Meeting of the Division for Planetary Sciences of the American Astronomical Society, Kona, HI, October 10, 1995.

M. A. Kolodner and P. G. Steffes, "The Microwave Absorption of Sulfuric Acid Vapor in the Venus Atmosphere," Bulletin of the American Astronomical Society, vol. 28, pp. 1116-1117. Presented at the 28th Annual Meeting of the Division for Planetary Sciences of the American Astronomical Society, Tucson, AZ, October 24, 1996.

S. H. Suleiman, M. A. Kolodner, B. J. Butler, and P. G. Steffes, "VLA Images of Venus at 1.3 cm and 2 cm Wavelengths," Bulletin of the American Astronomical Society, vol. 28, pg 1117. Presented

at the 28th Annual Meeting of the Division for Planetary Sciences of the American Astronomical Society, Tucson, AZ, October 24, 1996.

M. A. Kolodner, S. H. Suleiman, B. J. Butler, and P. G. Steffes. (1996). "The Abundance and Distribution of Sulfur-Bearing Compounds in the Lower Venus Atmospheres." EOS Trans. AGU 77, No. 46, Fall Meet. Suppl., p. F439. Presented December 16, 1996 at the Fall Meeting of the American Geophysical Union, San Francisco, CA.

V. CONCLUSION

Over the 13-year duration of this grant, an effective program integrating microwave and millimeter-wave laboratory measurements with observations conducted from spacecraft experiments and earth-based radio astronomical observations has been conducted. Substantial new results regarding the nature and distribution of tropospheric constituents in the atmospheres of Venus and the outer planets have been obtained. This work was acknowledged by the presentation of the 1996 IEEE Judith A. Resnik Award to the Principal Investigator with the citation, "for contributions to an understanding of the Venus atmosphere through innovative microwave measurements". Similar successes in analysis of the outer planets have also been achieved such as those described in our most recent paper, attached as Appendix B (DeBoer and Steffes, ICARUS, vol. 123, pp. 324-335, October 1996). It is expected that these successes will continue as our new grant from NASA/GSFC commences.

APPENDIX

RENEWAL PROPOSAL
AND
PROGRESS REPORT #22

ENTITLED

LABORATORY EVALUATION AND APPLICATION OF
MICROWAVE ABSORPTION PROPERTIES UNDER
SIMULATED CONDITIONS FOR PLANETARY ATMOSPHERES

to the

Planetary Atmospheres Program of the
National Aeronautics and Space Administration
for Grant NAGW-533

Principal Investigator:

Paul G. Steffes

School of Electrical and Computer Engineering
Georgia Institute of Technology
Atlanta, Georgia 30332-0250

Tel: (404) 894-3128

Fax: (404) 894-4641

e-mail: ps11@prism.gatech.edu

Report Period: November 1, 1995 through October 31, 1996

Proposed Renewal Period: November 1, 1996 through October 31, 1997

Submitted: July 1996

TABLE OF CONTENTS

COVER PAGES:

	<u>Page</u>
A. Cover Sheet	i
B. Table of Contents	ii
I. INTRODUCTION AND SUMMARY	1
II. PROGRESS REPORT	1
A. Laboratory Measurements under Simulated Venus Conditions	1
B. Venus Observations and Radiative Transfer Modelling	2
C. Other Accomplishments	5
III. PLANNED WORK FOR THE UPCOMING GRANT YEAR	5
IV. PROPOSED BUDGET	7
V. REFERENCES	8
VI. BIOGRAPHICAL SKETCH	9
VII. APPENDICES	

I. INTRODUCTION AND SUMMARY

Radio absorptivity data for planetary atmospheres obtained from spacecraft radio occultation experiments and earth-based radio astronomical observations can be used to infer abundances of microwave absorbing constituents in those atmospheres, as long as reliable information regarding the microwave absorbing properties of potential constituents is available. The use of theoretically-derived microwave absorption properties for such atmospheric constituents, or using laboratory measurements of such properties under environmental conditions which are significantly different than those of the planetary atmosphere being studied, often leads to significant misinterpretation of available opacity data. For example, laboratory measurements completed recently by Suleiman *et al.* (1996 reprints previously mailed) under this grant (NAGW-533), have shown that the opacity from, SO_2 under simulated Venus conditions is best described by a different lineshape than was previously used in theoretical predictions. The recognition of the need to make such laboratory measurements of simulated planetary atmospheres over a range of temperatures and pressures which correspond to the altitudes probed by both radio occultation experiments and radio astronomical observations, and over a range of frequencies which correspond to those used in both radio occultation experiments and radio astronomical observations, has led to the development of a facility at Georgia Tech which is capable of making such measurements. It has been the goal of this investigation to conduct such measurements and to apply the results to a wide range of planetary observations, both spacecraft and earth-based, in order to determine the identity and abundance profiles of constituents in those planetary atmospheres.

II. PROGRESS REPORT

A. Laboratory Measurements under Simulated Venus Conditions

Over the past five years, we have been active in using the Magellan spacecraft to probe the Venus atmosphere by way of radio occultation studies. One key aspect of the Magellan radio occultation results is the high percentage accuracy of the measured profiles of 13 cm and 3.6 cm absorptivity; typically $\pm 10\text{-}15\%$. To take advantage of these new profiles, so as to develop highly accurate abundance profiles of the microwave absorbing constituents, one must know the microwave absorbing and refracting properties of the constituents very accurately. Carbon dioxide (CO_2) is only a minor contributor to the microwave absorption at both wavelengths, but its absorption properties are well understood (Ho *et al.*, 1966); and since its abundance does not vary significantly in the Venus atmosphere, its effects can be directly subtracted. At 13 cm, the remaining opacity is almost all due to gaseous sulfuric acid (H_2SO_4). Sulfuric acid is, of course, the predominant constituent in the Venus clouds. Understanding the spatial and temporal variations in its gas-phase abundance gives insight into the dynamical processes which affect cloud formation, as well as into the thermochemical processes which constrain the abundances of other reactive constituents in the Venus atmosphere such as COS , H_2O , CO , SO_2 , and SO_3 . While significant headway has been made in developing a theoretically-derived line catalog of the microwave resonances of H_2SO_4 (see Poynter *et al.*, 1994), large uncertainties in the broadening parameters of the 55,563 microwave lines makes estimates of their combined opacity at 13 cm highly uncertain (\sim factor of two).

The best laboratory characterization of the 13 cm opacity from gaseous H_2SO_4 was conducted under this grant in 1984. (Steffes, 1985) The measurements had accuracies of $\pm 50\%$ which far exceeded the accuracies of the opacity data at that time, and dramatically reduced the uncertainties (\pm factor-of-seven) of previous estimates of gaseous H_2SO_4 opacity. However, now that much better measurements of Venus atmospheric absorptivity have been made, better laboratory measurements are necessary.

In the currently completed grant year (November 1, 1995 - October 31, 1996), we have begun a program to more accurately characterize the microwave absorption properties of sulfuric acid vapor (H_2SO_4) in a CO_2 atmosphere. The approach used in measuring the microwave absorptivity of gaseous H_2SO_4 in a CO_2 atmosphere is similar to those previously used by Suleiman *et al.* (1996) for the absorptivity of SO_2 in a CO_2 atmosphere under simulated Venus conditions, except that a flask of liquid H_2SO_4 is used to generate the H_2SO_4 vapor, when heated. As can be seen in Figure 1, the absorptivity of the gas mixture is measured by observing the effects of the introduced gas mixture on the Q, or quality factor, of the particular resonances of the two resonators contained in the pressure vessel. The changes in the Q are monitored by the computer-controlled spectrum analysis system, since Q is simply the ratio of the resonant frequency to the half-power bandwidth. Note also that changes in the resonant frequencies themselves are related to the refractivities of the gas mixture at those resonant frequencies, and is likewise important information for the proper interpretation of radio occultation data.

As in our previous work with gaseous H_2SO_4 (Steffes, 1985, 1986), we create a $\text{CO}_2 / \text{H}_2\text{SO}_4$ mixture by first loading a precisely known volume of liquid H_2SO_4 into the sample flask and then heating the temperature chamber containing the pressure vessel and flask to a high operating temperature ($\sim 560\text{K}$). This assures a large mixing ratio, since it is the vapor which evaporates from the liquid H_2SO_4 which will form part of the mixture. In past experiments, one large source of uncertainty rose from potential changes in the H_2SO_4 mixing ratio caused by reactions with the silver plating on the resonators, which made determination of the actual amount of sulfuric acid vapor difficult. In the new experiments, we have used gold-plated resonators, thus eliminating the effects of reactions.

In Figure 2, the results from the initial absorptivity measurements are shown. These absorptivities are normalized by the sulfuric acid mixing ratio in a CO_2 atmosphere. Additional measurements will be completed by August 1996, so as to develop the most accurate formalism for H_2SO_4 opacity.

B. Venus Observations and Radiative Transfer Modelling

In October 1995, a proposal was submitted to the National Radio Astronomy Observatory (NRAO) for use of the Very Large Array (VLA) for mapping the 1.3 cm and 2 cm emission from Venus. (See Appendix A.) These wavelengths were chosen since they are especially sensitive to the opacity from SO_2 (1.3 cm) and H_2SO_4 (2 cm). (See Suleiman *et al.*, 1996 and Kolodner and Steffes, 1995.) The observations were conducted on April 5, 1996 by graduate students Shady H. Suleiman and Marc A. Kolodner, assisted by Dr. Brian Butler from NRAO. Initial inspection of the maps derived from these observations (See Figures 3 and 4) show darkened regions at latitudes greater than 60 degrees. These darkened regions are larger and more pronounced than simple "limb darkened" zones expected from a uniform disk. They are consistent with the polar darkening observed by the Pioneer Venus

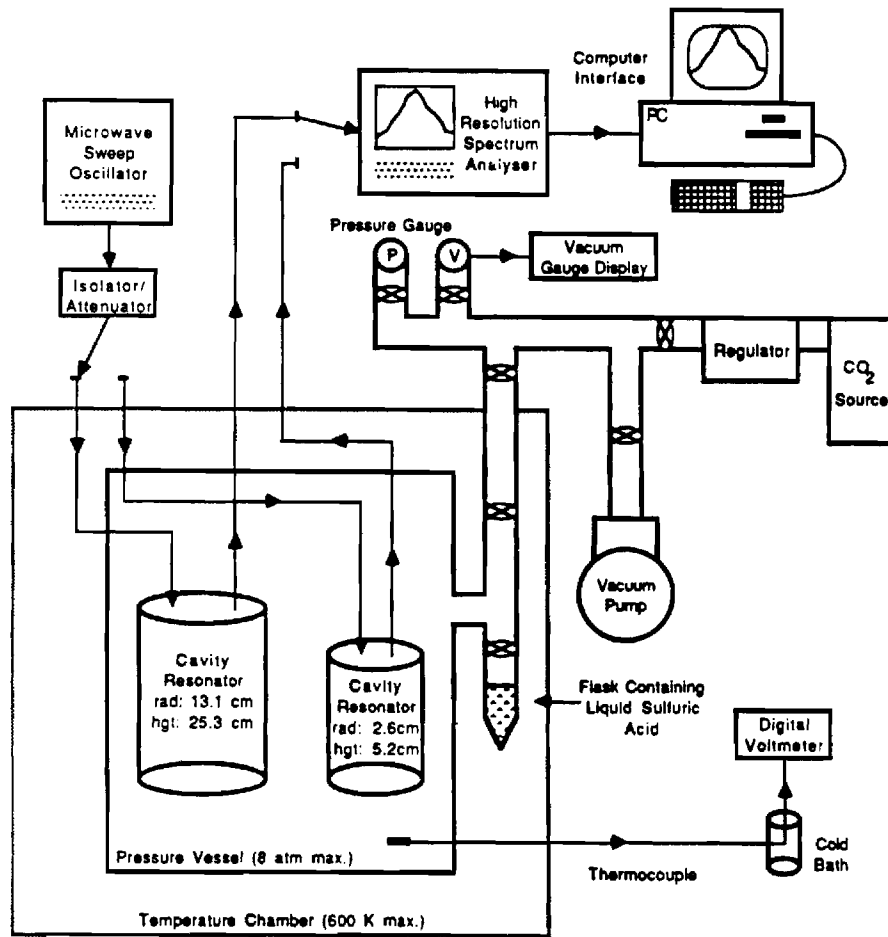
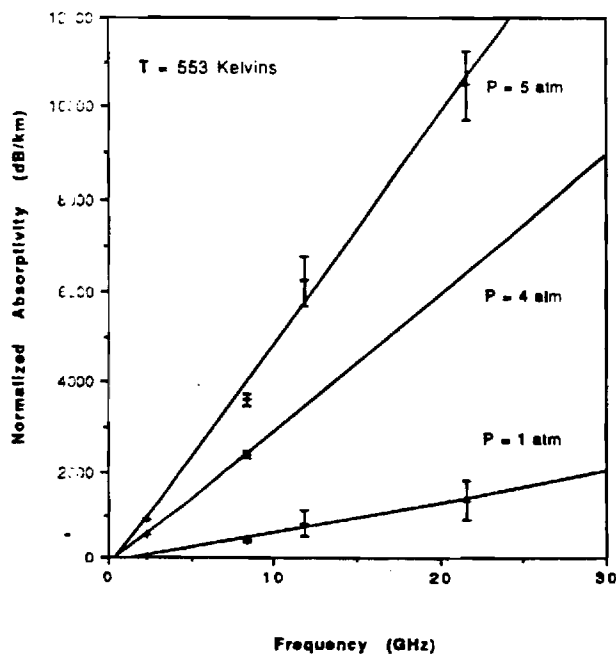

Fig.1: Block diagram of the atmospheric simulator, as configured for measurements of the microwave absorption of gaseous sulfuric acid under Venus atmospheric conditions.

Fig 2 (below): Measured absorptivity (normalized by mixing ratio) of gaseous H_2SO_4 in a CO_2 atmosphere as a function of pressure and frequency.

H2SO4 Opacity Data



H2SO4 Opacity Data

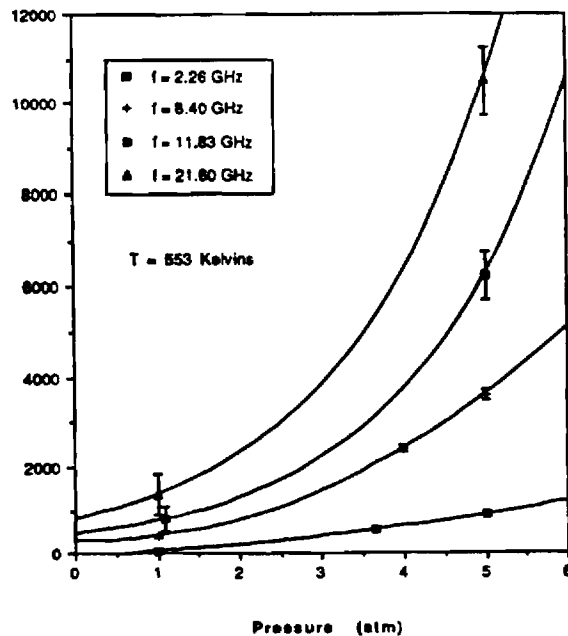

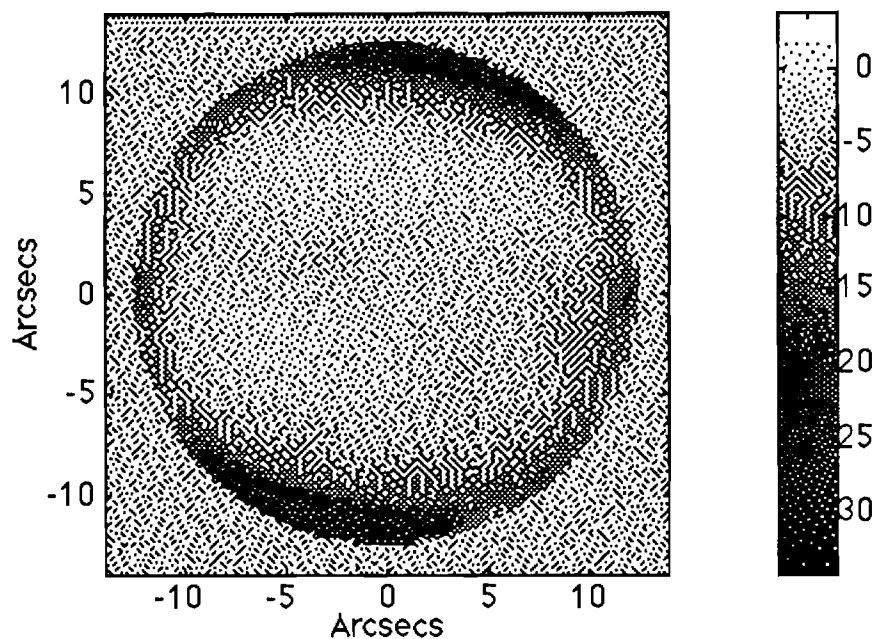

Figure 3: Map of 2 cm Venus emission (residual relative to emission from uniformly opaque sphere.)

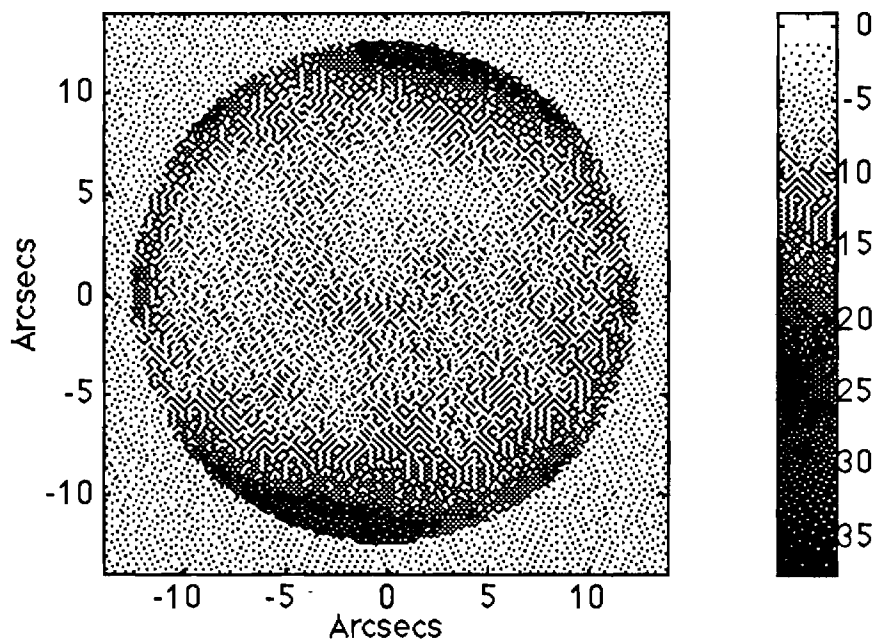

Figure 4: Map of 1.3 cm Venus emission (residual relative to emission from uniformly opaque sphere.)

Orbiter Infrared Radiometer (OIR) experiment (Taylor, *et al.*, 1980). These emission maps will be interpreted using our radiative transfer models, which will incorporate the new formalisms for the opacity from SO₂ and gaseous H₂SO₄.

C. OTHER ACCOMPLISHMENTS

In October 1995, three (3) conference presentations were made at the 1995 AAS/DPS meeting (Kolodner and Steffes, 1995; Suleiman and Steffes, 1995, and DeBoer and Steffes, 1995). The abstracts for these presentations are attached as Appendix B. Two refereed journal papers were also published: Suleiman *et al.* (1996, reprints previously mailed) and DeBoer and Steffes (1996a, reprints will be mailed when received from publisher). A third refereed paper (DeBoer and Steffes, 1996b) has recently been accepted for publication in *Icarus*. (Preprints were previously mailed) Additionally, the 1996 IEEE Judith A. Resnik Award was presented to the Principal Investigator of this grant with the citation, "for contributions to an understanding of the Venus atmosphere through innovative microwave measurements," acknowledging work accomplished under this grant.

III. PLANNED WORK FOR THE UPCOMING GRANT YEAR

(November 1, 1996 - October 31, 1997)

Once the high-accuracy laboratory measurements of the absorptivity and refractivity of gaseous H₂SO₄ are completed, an analytical formalism will be developed, using the existing Poynter/Pickett/Cohen line catalog (1994), which will allow accurate computation of the opacity of the H₂SO₄ under Venus conditions. The formalism to be developed fits the laboratory data to the combined effects of all 55,563 lines by selecting the proper lineshape formalism (Van Vleck-Weisskopf, Ben Reuven, Gross, etc.), in a similar fashion to that used previously to develop formalisms for SO₂ (Suleiman, *et al.*, 1996).

The new formalism will be directly applied to the 13 cm Magellan absorptivity profiles (after subtracting the known absorption from CO₂) to develop high accuracy H₂SO₄ abundance profiles for the Venus atmosphere. Additionally, by using the new profiles and our formalism, we can subtract the effects of the absorption of H₂SO₄ (and CO₂) from the 3.6 cm absorptivity profiles and be left with only absorption due to SO₂, which will then be used to derive SO₂ abundance profiles, using the new formalism we have developed for SO₂ opacity (Suleiman *et al.*, 1996). Details of the new H₂SO₄ formalism will, of course, be published and also provided to investigators working with Venus absorptivity data (e.g. Jenkins at SETI Institute/NASA Ames) so as to be used in developing their new results.

Of equal interest will be the application of this formalism to our microwave radiative transfer model for Venus. A new model for the microwave emission from Venus has been developed by Graduate Student, Mark Kolodner, which is innovative in its full analysis of the effects of atmospheric refraction on limb emission and in its use of Magellan results for modelling the centimeter wavelength surface emission. The first application of this model was described in Suleiman *et al.* (1996) where the model used the new formalism for SO₂ absorption to place limits on the abundance of SO₂ in the Venus atmosphere, based on disk-averaged observations of the centimeter-wavelength emission.

One key result of the new modeling effort is the determination that the 20-25 GHz range is the most sensitive portion of the Venus microwave emission spectrum to subcloud SO₂. This is significant in that it includes the 1.3 cm wavelength observed with the VLA. Thus, new maps of the 1.3 cm Venus emission can be used to detect spatial variations in the abundance and distribution of SO₂. Similarly, based on our new model for the opacity from gaseous H₂SO₄, it appears as if the 2 cm wavelength emission is especially sensitive to sub-cloud abundance of gaseous H₂SO₄. Thus, the new 2 cm emission maps will be interpreted using our radiative transfer model incorporating the new formalisms for the opacity from SO₂ and gaseous H₂SO₄.

Finally, after the laboratory measurements of gaseous H₂SO₄ are complete, the measurement system will be re-constructed in preparation for measurements of the microwave properties of phosphine (PH₃) under simulated Neptune conditions.

Results from both the laboratory studies and observational work will be presented at the 28th Annual Meeting of the Division for Planetary Sciences of the American Astronomical Society in Tucson, AZ (October 23-26, 1996). These results will also be submitted for publication in Icarus.

IV. PROPOSED BUDGET

PRINCIPAL INVESTIGATOR: Paul G. Steffes (Georgia Institute of Technology)

TITLE: Laboratory Evaluation and Application of Microwave Absorption Properties Under Simulated Conditions for Planetary Atmospheres

GRANT NUMBER: NAGW-533
For the period of November 1, 1996 through
October 31, 1997 (Second year of 3-year program)

ESTIMATED COST BREAKDOWN

I.	DIRECT SALARIES AND WAGES*:	\$ 41,260
A.	Principal Investigator Paul G. Steffes 22% time, calendar year (.20 person-years)	\$ 22,329
B.	1 Graduate Student (. S. H. Suleiman) 50% time, calendar year (.5 person-years)	\$ 15,900
C.	1 Senior Administrative Secretary 12% time, calendar year (.12 person-years)	<u>\$ 3,031</u>
II.	FRINGE BENEFITS**: 24.8% of Direct Salaries & Wages (less students)	\$ 6,289
III.	MATERIALS, SUPPLIES, AND SERVICES	\$ 1,500
A.	Gases, liquids, and supplies (microwave connectors and o-rings) for Experiments	\$ 900
B.	Miscellaneous Project Supplies (data storage media and page charges)	<u>\$ 600</u>
IV.	TRAVEL	<u>\$ 1,300</u>
A.	Travel for Student to AAS/DPS Meeting (Boston, MA, 5 days duration, airfare \$600 plus registration and \$ 100/day)	<u>\$ 1,300</u>
	SUBTOTAL - ESTIMATE OF DIRECT COSTS:	\$ 50,349
V.	OVERHEAD (Indirect Expense)**: 43% of Modified Total Direct Cost Base	<u>\$21,651</u>
	TOTAL FIRST YEAR BUDGET REQUESTED FROM NASA:	<u>\$72,000</u>

SUMMARY OF STAFFING REQUEST: SEE SECTION I (ABOVE)

* The salary and wage rates are based on FY97 salaries for the Georgia Institute of Technology. The Georgia Tech Fiscal Year is July 1 through June 30.

** Rates are for the period July 1, 1996 through June 30, 1997 and are subject to adjustment upon DCAA audit and ONR negotiations.

V. REFERENCES

- DeBoer, D. R. and P. G. Steffes, 1995. "Potential Effect of Phosphine (PH₃) on the Microwave and Millimeter Wave Opacity and Emission from the Atmosphere of Neptune." Bulletin of the American Astronomical Society, 27, 108. Presented at the 26th Annual Meeting of the Division for Planetary Sciences of the American Astronomical Society, Kona, HI, October 10, 1995.
- DeBoer, D. R. and P. G. Steffes, 1996a. The Georgia Tech high sensitivity microwave measurement system. Astrophysics and Space Science 236, 111-124.
- DeBoer, D. R. and P. G. Steffes, 1996b. Estimates of the tropospheric vertical structure of Neptune based on radiative transfer studies, in press.
- Ho, W., I. A. Kaufman, and P. Thaddeus, 1966. Laboratory measurements of microwave absorption in models of the atmosphere of Venus. J. Geophys. Res. 71, 5091-5108.
- Kolodner, M. A., and P. G. Steffes, 1995. "New Laboratory Measurements of the Microwave Opacity of Sulfuric Acid under Simulated Venus Conditions." Bulletin of the American Astronomical Society, 27, 1071-1072. Presented at the 27th Annual Meeting of the Division for Planetary Sciences of the American Astronomical Society, Kona, HI, October 9, 1995.
- Poynter, R. L., H. M. Pickett, and E. A. Cohen, 1994. Submillimeter, millimeter and microwave spectral line catalog. Available on-line via FTP from JPL. Described by Poynter, R. L. and H. M. Pickett, 1985 (same title), Applied Optics 24, 2235-2240.
- Suleiman, S. H., and P. G. Steffes, 1995. "Radiative Transfer Models for Venus Microwave and Millimeter-Wave Emission using a Ben-Reuven Formalism for SO₂ Absorption". Bulletin of the American Astronomical Society 27, 1071. Presented at the 27th Annual Meeting of the Division for Planetary Sciences of the American Astronomical Society, Kona, HI, October 9, 1995.
- Suleiman, S. H., M. A. Kolodner, and P. G. Steffes, 1996. Laboratory measurement of the temperature dependence of gaseous sulfur dioxide (SO₂) microwave absorption with application to the Venus atmosphere. Journal of Geophysical Research (Planets) 101, 4623-4635.
- Taylor, F. W., R. Beer, M. T. Chahine, D. J. Diner, L. S. Elson, R. D. Haskins, D. J. McCleese, J. V. Martonchik, and P. E. Reichley, 1980. Structure and meteorology of the middle atmosphere of Venus: Infrared remote sensing from the Pioneer Orbiter. Journal of Geophysical Research 85, 7963-8006.

VLA OBSERVING APPLICATION

A

rcvd:

DEADLINES: 1st of Feb., June., Oct. for next configuration following review
 INSTRUCTIONS: Each numbered item must have an entry or N/A
 SEND TO: Director NRAO, 520 Edgemont Rd., Charlottesville, VA 22903-2475

- (1) Date Prepared: September 25, 1995
 (2) Title of Proposal: Mapping SO₂ and H₂SO₄ on Venus.

(3) AUTHORS	INSTITUTION	Who Will Come To The VLA?	For Grad Students Only	
			Observations For Ph.D. Thesis?	Anticipate Ph.D. Year
Shady H. Suleiman	Georgia Institute of Technology	X	Yes	1996
Marc A. Kolodner	Georgia Institute of Technology	X	Yes	1996
Dr. Bryan Butler	National Radio Astronomy Observatory	X		
Prof. Paul G. Steffes	Georgia Institute of Technology			

(4) Related VLA previous proposal number(s): AS330

(5) Contact author

for scheduling: Prof. Paul G. Steffes

address: School of Electrical and Computer Engineering
 Georgia Institute of Technology
 Atlanta, Ga. 30332-0250

(6) Telephone: (404)894-3128

Telex: N/A

Internet: paul.steffes@ee.gatech.edu
 Other E Mail: ps11@prism.gatech.edu
 Telefax: (404)853-9171

(7) Scientific Category: astrometry, geodesy & techniques, solar, propagation, planetary, stellar, pulsar,
 ISM, galactic center, galactic structure & dynamics (HI), normal galaxies, active galaxies, cosmology

(8) Configurations (one per column) (A, B, C, D, BnA, CnB, DnC, Any)	C				
(9) Wavelength(s) (400, 90, 20, 18, 6, 3.5, 2, 1.3, 0.7 cm)	1.3 and 2 cm				
(10) Time requested (hours)	12				

(11) Type of observation: mapping, point source, monitor, continuum, lin poln, circ poln, solar, VLB
 (check all that apply) spectroscopy, multichannel continuum, phased array, pulsar, high-time resolution
 other _____

(12) ABSTRACT (Do not write outside this space. Please type.)

A VLA observation of Venus is proposed to obtain high resolution continuum maps at frequencies of 15 GHz and 22 GHz. These emission maps will be used to detect potential spatial (logitudinal and latitudinal) variations in the abundances of gaseous sulfur dioxide (SO₂) and gaseous sulfuric acid (H₂SO₄) across the disk of the planet. The suggested observation time is in early April 1996 while the VLA is in the C-configuration. The time requested for this observation is 12 hours which can be divided on two consecutive days (6 hours per day).

(13) Observer present for observations? Yes No Data reduction at? Home AOC or CV (2 weeks notice)

(14) Help required: None Consultation Friend (extensive help)

(15) Spectroscopy Only:	line 1	line 2	line 3	line 4
Transition (HI, OH, etc.)	_____	_____	_____	_____
Rest Frequency (MHz)	_____	_____	_____	_____
Velocity (km/s)	_____	_____	_____	_____
Observing frequency (MHz)	_____	_____	_____	_____
Correlator mode	_____	_____	_____	_____
IF bandwidth(s) (MHz)	_____	_____	_____	_____
Hanning smoothing (y/n)	_____	_____	_____	_____
Number of channels per IF	_____	_____	_____	_____
Frequency Resolution (kHz/channel)	_____	_____	_____	_____
Rms noise (mJy/bm, nat. weight., 1 hr)	_____	_____	_____	_____
Rms noise (K, nat. weight., 1 hr)	_____	_____	_____	_____

(16) Number of sources 1 (If more than 10 please attach list. If more than 30 give only selection criteria and LST range(s).)

(17) NAME	Epoch: 1950 <input type="checkbox"/> 2000 <input checked="" type="checkbox"/>		Config.	Band-width (cm)	Band-width (MHz)	Total Flux		Largest angular size	Required rms (mJy/bm)	Time requested (hours)
	RA hhmm	Dec ± xx.x°				line (Jy)*	cont. (Jy)			
Venus	3 37	22.7	C	1.3	50	N/A	86	28 "	0.0724	12
			C	2	50	N/A	39	28 "	0.0416	

*this should be the total flux at the peak of the line

Notes to the table (if any): Observation will be conducted at 15 GHz (2 cm) and 22 GHz (1.3 cm) simultaneously.

(18) Restrictions to elevation (other than hardware limits) or HA range (give reason): None

(19) Preferred range of dates for scheduling (give reason): Preferred: April 1-15, 1996. Acceptable: Feb. 9-April 15, 1996.

(20) Dates which are not acceptable: All other times.

(21) Special hardware, software, or operating requirements: N/A

(22) Please attach a self-contained Scientific Justification not in excess of 1000 words. (Preprints or reprints will be IGNORED!)

Please include the full addresses (postal and e-mail) for first-time users or for those that have moved (if not contact author).

When your proposal is scheduled, the contents of the cover sheets become public information (Any supporting pages are for refereeing only).

We propose to observe Venus using the Very Large Array (VLA) at 15 GHz and 22 GHz simultaneously. The objective of this observation is to obtain high resolution continuum maps of Venus. These emission maps will be used to detect potential spatial (longitudinal and latitudinal) variations in the abundances of gaseous sulfur dioxide (SO_2) and gaseous sulfuric acid (H_2SO_4) across the disk of the planet. Statistically significant large-scale variations in the 13 cm absorptivity profiles of the sub-cloud Venus atmosphere were observed from the Pioneer-Venus radio occultation data (Jenkins et al., 1991). In addition, small-scale variations in the 3.6 cm and 13 cm opacity profiles were detected from the 1991 Magellan radio occultation measurements (Jenkins et al., 1994). Finally, small and large-scale variations in the emission from the lower atmosphere of the planet were observed in the near infrared images of the nightside of Venus during the Galileo encounter (Carlson et al., and Crisp et al., 1991). These features are likely caused by variations in the sulfur-bearing gases in the lower Venus atmosphere where strong dynamical forces are present.

The frequencies of observation were selected based on their sensitivity to these constituents, as determined using our radiative transfer model. This model incorporates a newly developed Ben-Reuven formalism which provides a more accurate characterization of the microwave absorption of gaseous SO_2 [Suleiman et al., 1995]. The model also uses the most current spectral line catalog [Poynter et al., 1994] to compute the microwave absorption of gaseous H_2SO_4 . A 150 ppm mixing ratio of gaseous SO_2 below the main cloud layer (based on uniform mixing) is used which is in agreement with recent infrared Earth-based observations [see Bezard et al., 1993]. This SO_2 mixing ratio also compares well with previous spacecraft in situ measurements [see Oyama et al., 1980 and Gelman et al., 1979]. A 20 ppm mixing ratio of gaseous H_2SO_4 between 38 and 48 km is used which is consistent with the results from the 1991 Magellan radio occultation experiments [see Jenkins et al., 1994]. Figure 1 shows the range of projected differences in the flux density per beam for a viewing angle of 0° (nadir) as a function of frequency between a Venus atmosphere with only carbon dioxide (CO_2), nitrogen (N_2), and water vapor (H_2O) and a Venus atmosphere with CO_2 , N_2 , H_2O , and SO_2 . Figure 2 shows the range of projected differences in the flux density per beam for a viewing angle of 0° (nadir) as a function of frequency between a Venus atmosphere with only CO_2 , N_2 , H_2O , and SO_2 and a Venus atmosphere with CO_2 , N_2 , H_2O , SO_2 , and H_2SO_4 . Note from Figures 1 and 2 that the largest drop in the flux density at nadir due to the absorption from gaseous SO_2 and gaseous H_2SO_4 occurs in the K-band (20-25 GHz) and U-band (12-16 GHz) portions of the emission spectrum, respectively. Thus, simultaneous observations in these regions would be most sensitive to detecting potential spatial variations in the abundances of gaseous SO_2 and gaseous H_2SO_4 which are correlated in position and time and are both contributing to the integrated opacity at each frequency.

Although an observation of the Venus emission was conducted with the VLA in December 1981 at 15 GHz and 22 GHz [Janssen et al., 1982], images obtained at both frequencies had large rms noise levels (± 10 Kelvins or more). Thus, measurements of the effects of gaseous SO_2 at 22 GHz and gaseous H_2SO_4 at 15 GHz from these images were difficult since the possible variations in the brightness temperature are only on the order of 5-10 Kelvins at both frequencies. The current system is significantly more sensitive and thus, less noisy images could be obtained.

We suggest conducting the observation in February through mid April 1996, when the VLA will be in the C-configuration. The apparent angular diameter of Venus will be about 15-30 arc-sec and its distance from Earth will be about 0.7 a.u. The time requested for this observation is 12 hours which can be divided on two consecutive days (6 hours per day), if necessary. This requested time includes both the on-source integration time and the calibration time which is chosen such as to optimize coverage in the U-V plane and hence construct a reasonable continuum image.

References

- [] Bezard, B., C. de Bergh, B. Fegley, J.P. Maillard, D. Crisp, T. Owen, J. B. Pollack, and D. Grinspoon, The Abundance of Sulfur Dioxide Below the Clouds of Venus, *Geophys. Res. Lett.*, 20, 15, 1587-1590, 1993.
- [] Carlson, R. W., K. H. Baines, T. Encrenaz, F. W. Taylor, P. Drossart, L. W. Camp, J. B. Pollack, E. Lellouch, A. D. Collard, S. B. Calcutt, D. Grinspoon, P. R. Weissman, W. D. Smythe, A. C. Ocampo, G. E. Danielson, F. P. Fanale, T. V. Johnson, H. H. Kieffer, D. L. Matson, T. B. McCord, and L. A. Soderblom, Galileo infrared imaging spectroscopy measurements at Venus, *Science*, 253, 1541-1548, 1991.
- [] Crisp, D., S. McMuldroy, S. K. Stephens, W. M. Sinton, B. Ragent, K. W. Hodapp, R. G. Probst, L. R. Doyle, D. A. Allen, and J. Elias, Ground-based near-infrared imaging observations of Venus during the Galileo encounter, *Science*, 253, 1538-1541, 1991.

- [] Gelman, B. G., V. G. Zolotukhin, L. M. Mukhin, N. I. Lamonov, B. V. Levchuk, D. F. Nenarokov, B. P. Okhotnikov, V. A. Rotin, and A. N. Lipatov, Gas Chromatograph Analysis of the Chemical Composition of the Venus Atmosphere, *Space Res.*, 20, 219, 1979.
- [] Janssen, M. A., M. J. Klein, G. L. Berge, and D. O. Muhleman, High resolution Microwave Imagery of the Venus Atmosphere, Presented at the XVIII General Assembly of the International Astronomical Union, Patras, Greece, August 17-26, 1982.
- [] Jenkins, J. M. and P. G. Steffes, Results for 13 cm absorptivity and H₂SO₄ abundance profiles from the Season 10 (1986) Pioneer-Venus orbiter radio occultation experiment, *Icarus*, 90, 129-138, 1991.
- [] Jenkins, J. M., P. G. Steffes, D. P. Hinson, J. D. Twicken, and G. L. Tyler, Radio Occultation Studies of the Venus Atmosphere with the Magellan Spacecraft: II. Results from the October 1991 Experiments, *Icarus*, 110, 79-94, 1994.
- [] Oyama, V. I., G. C. Carle, F. Woeller, J. B. Pollack, R. T. Reynolds, and R. A. Craig, Pioneer Venus Gas Chromatography of the Lower Atmosphere of Venus, *J. Geophys. Res.*, 85, 7891-7902, 1980.
- [] Poynter, R. L., H. M. Pickett, and E. A. Cohen, Submillimeter, Millimeter, and Microwave Spectral Line Catalog. Available On-Line Via FTP from JPL. Described by Poynter, R. L. and H. M. Pickett, (same title), *Applied Optics*, 24, 2235-2240, 1985.
- [] Suleiman, S. H., M. A. Kolodner, and P. G. Steffes, Laboratory Measurement of the Temperature Dependence of Gaseous Sulfur Dioxide (SO₂) Microwave Absorption with Application to the Venus Atmosphere, Submitted to *Journal of Geophysical Research (Planets)*, March 1995.

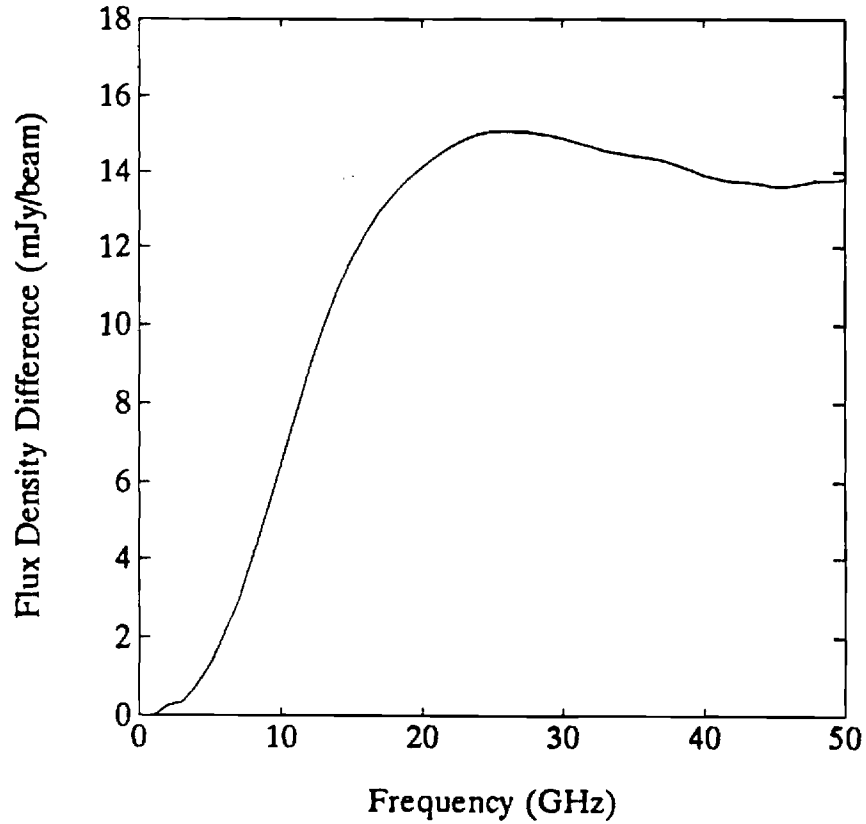

Figure 1: Range of projected differences in the flux density per beam for a viewing angle of 0° (nadir) as a function of frequency between a Venus atmosphere with only CO_2 , N_2 , and H_2O and a Venus atmosphere with CO_2 , N_2 , H_2O , and SO_2 . The mixing ratio for gaseous SO_2 is 150 ppm (uniformly mixed) below 48 km.

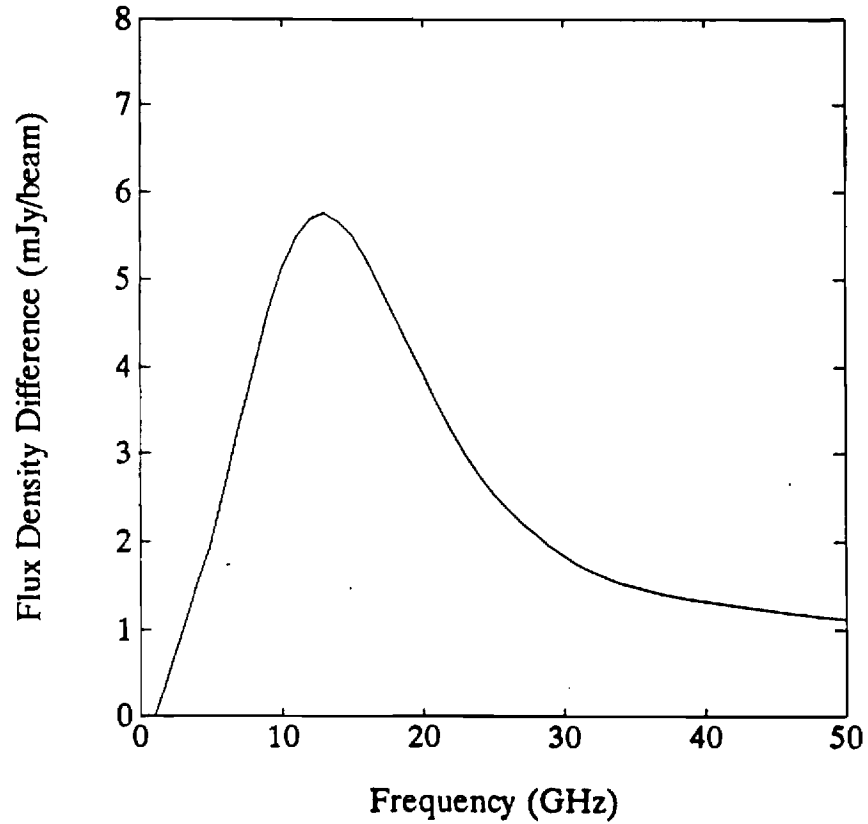

Figure 2: Range of projected differences in the flux density per beam for a viewing angle of 0° (nadir) as a function of frequency between a Venus atmosphere with only CO_2 , N_2 , H_2O , and SO_2 and a Venus atmosphere with CO_2 , N_2 , H_2O , SO_2 , and H_2SO_4 . The mixing ratio for gaseous H_2SO_4 is 20 ppm for altitudes between 38 and 48 km.

New Laboratory Measurements of the Microwave Opacity of Sulfuric Acid Vapor under Simulated Venus Conditions

M. A. Kolodner (School of Physics, Georgia Institute of Technology, Atlanta, Georgia, 30332-0430), P. G. Steffes (School of Electrical and Computer Engineering, Georgia Institute of Technology, Atlanta, Georgia, 30332-0250)

New laboratory measurements of the microwave opacity of H₂SO₄ in a CO₂ environment are being performed at 2.25 GHz (13.3 cm), 8.54 GHz (3.5 cm), 16.4 GHz (1.83 cm), and 21.7 GHz (1.38 cm) at a temperature of 590 Kelvins and at pressures ranging from 2 to 6 atmospheres. The experimental setup and approach is similar to that used by Steffes (*Icarus* 64, p. 576, 1985 & *Astrophys. J.* 310, p. 482, 1986) but a significant reduction in the uncertainty of the measurements is achieved due to our ability to account for changes in the dielectric properties of the resonators when a lossy gaseous mixture is introduced into them. Based on our absorptivity measurements and the new Poynter-Pickett-Cohen spectral line catalog for H₂SO₄, a new line shape model is being developed. This model, together with a Ben-Reuven line shape model for the microwave opacity of gaseous SO₂ in a CO₂ environment developed by Suleiman et al. (submitted to *JGR Planets*, April 1995), will be incorporated into a radiative transfer model to evaluate the microwave emission spectrum of Venus. Based on radio observations of Venus, new estimates on the disk averaged abundances of gaseous SO₂ and H₂SO₄ vapor in the Venus atmosphere can be inferred. Finally, these microwave opacity models will be used to infer specific abundance profiles of gaseous SO₂ and H₂SO₄ vapor from measured absorptivity profiles of the Venus atmosphere obtained during the 1991 Magellan radio occultation experiments (Jenkins et al., *Icarus* 110, p. 79, 1994).

This work is being supported by the NASA Planetary Atmospheres Program under grant NAGW-533.

Abstract submitted for DPS [Division for Planetary Sciences] meeting

Date submitted: LPI electronic form version 5/95

Division for Planetary Sciences Abstract Form

DPS Category 3

Running #

Session 0.00

Oral preferred Poster preferred Either

Is this your first DPS presentation? Yes No

Would you be willing to act as Session Chair? Yes No

Is your abstract newsworthy, and if so, would you be willing to prepare a news release and be available for interviews with reporters?

Yes No Maybe

Paper presented by Marc A. Kolodner
2515 N.E. Expy., W6
Atlanta, GA 30345
Phone: 404-320-6250
Fax: 404-853-9171
Email: gt8712a@prism.gatech.edu

Special instructions:

Membership Status (First Author):

DPS-AAS Member Non-Member

Student Member Student Non-Member

Sponsor: Paul G. Steffes

Radiative Transfer Models for Venus Microwave and Millimeter-Wave Emission using a Ben-Reuven Formalism for SO₂ Absorption

S. H. Suleiman, P. G. Steffes (School of Electrical and Computer Engineering, Georgia Institute of Technology, Atlanta, Georgia, 30332-0250)

Several abundance profiles for gaseous sulfur dioxide (SO₂) in the Venus atmosphere have been inferred from spacecraft experiments and Earth-based radio astronomical observations (Oyama *et al.*, *J. Geophys. Res.* 85, 8141-8150, 1980; Hoffman *et al.*, *J. Geophys. Res.* 85, 7882-7890, 1980; Gelman *et al.*, *Space Res.* 20, 219, 1979; Bertaux *et al.*, submitted to *J. Geophys. Res.*, 1995; Bezdard *et al.*, *Geophys. Res. Lett.* 20, 15, 1587-1590, 1993; Good and Schloerb, *Icarus* 53, 538-547, 1983; Steffes *et al.*, *Icarus* 84, 83-92, 1990). A radiative transfer model has been developed to examine the effects of these SO₂ abundance profiles on the microwave and millimeter-wave emission of Venus. This model incorporates the newly developed Ben-Reuven line shape formalism (Suleiman *et al.* submitted to *J. Geophys. Res.*, 1995) which provides a more accurate characterization of gaseous SO₂ absorptivity in the Venus atmosphere as compared to other formalisms. The resulting brightness temperature spectra using these abundance profiles are compared with existing observations to examine their consistency. Furthermore, a future observation of Venus using the Very Large Array (VLA) is proposed at 1.3 and 2 cm. This observation along with the measured results from the Magellan radio occultation experiments (Jenkins *et al.*, *Icarus* 110, 79-94, 1994) will enable us to resolve the spatial and temporal variations of SO₂ abundance in the Venus atmosphere.

This work was supported by the NASA Planetary Atmospheres Program under grant NAGW-533.

Abstract submitted for DPS [Division for Planetary Sciences] meeting

Date submitted: LPI electronic form version 5/95

Division for Planetary Sciences Abstract Form

DPS Category 3 Running # Session 0.00

Oral preferred Poster preferred Either

Is this your first DPS presentation? Yes No

Would you be willing to act as Session Chair? Yes No

Is your abstract newsworthy, and if so, would you be willing to prepare a news release and be available for interviews with reporters?

Yes No Maybe

Paper presented by Shady H. Suleiman
328835 GA. Tech Station
Atlanta, GA 30332-1240
Phone: 404-894-5280
Fax: 404-853-9171
Email: gt8835c@prism.gatech.edu

Special instructions:

Membership Status (First Author):

DPS-AAS Member Non-Member

Student Member Student Non-Member

Sponsor: Paul G. Steffes

Potential Effects of Phosphine (PH₃) on the Microwave and Millimeter Wave Opacity and Emission from the Atmosphere of Neptune

D. R. DeBoer (Hughes STX Corp., Greenbelt, MD 20770), P. G. Steffes (School of Elec. and Comp. Eng., Georgia Inst. of Tech., Atlanta, GA 30332-0250)

In order to best match the most reliable disk-averaged microwave and millimeter-wave emission measurements of Neptune (1 mm to 20 cm) and not exceed the measurements of 13 cm and 3.6 cm absorptivity made by Voyager 2 at Neptune (Lindal, *Astron J.* 103, 967-982), a Neptune atmosphere where the abundance of H₂S is greater than that of NH₃ below the putative NH₄SH cloud in the deep atmosphere is required (DeBoer and Steffes, *B.A.A.S.* 26, 1094, 1994). While such an atmosphere (e.g. 78% H₂, 19% He, 3% CH₄, plus 40 x solar H₂S and 0.2 x solar NH₃) gives an excellent fit to the microwave and millimeter-wave emission spectra, its opacity is too low at 13 cm and 3.6 cm to explain the Voyager radio occultation results. It is possible, however, to match both the emission spectra *and* the Voyager results by adding phosphine (PH₃) to the model.

Phosphine has been detected on Jupiter and Saturn at its strong rotational resonance (267 GHz, see, e.g., Weisstein and Serabyn, *Icarus* 84, 367-381). The results from Saturn inferred a 10x solar abundance. Preliminary estimates with our Neptune radiative transfer model suggest that a PH₃ abundance between 10x and 20x solar best fits the the microwave data. Estimates of the microwave absorption spectrum of PH₃ have been made using the Poynter, Pickett, and Cohen line catalog (available *on-line* from JPL), and assuming Van Vleck-Weisskopf lineshapes with a range of possible broadening parameters. In the future, we plan to conduct laboratory measurements of the cm and mm wave opacity of PH₃ in an H₂/He atmosphere to more accurately predict this effect.

This work has been supported by the NASA Planetary Atmospheres Program under Grant NAGW-533.

Abstract submitted for DPS [Division for Planetary Sciences] meeting

Date submitted: LPI electronic form version 5/95

Division for Planetary Sciences Abstract Form

DPS Category 11 Running # Session 0.00

Oral preferred Poster preferred Either

Is this your first DPS presentation? Yes No

Would you be willing to act as Session Chair? Yes No

Is your abstract newsworthy, and if so, would you be willing to prepare a news release and be available for interviews with reporters?

Yes No Maybe

Paper presented by David R. DeBoer
Hughes-STX Corp.
7701 Greenbelt Rd. Suite 400
Greenbelt MD 20770
Phone: 301-441-4075
Fax: 301-286-1754
Email: deboer@hoss.stx.com

Special instructions:

Membership Status (First Author):

DPS-AAS Member Non-Member

Student Member Student Non-Member

Sponsor: